

Mechanical Surface Treatment Solutions

PRODUCT CATALOG

Who We Are

Osborn has been a leader in mechanical surface treatment solutions for over 130 years. Through our company's history, we've experienced world wars, economic downturns, and fierce competition, but we continued to expand into new markets and innovate in our category. The secret to our success? We've never lost focus on what's most important—our customers.

130+

years of experience

1,250+

employees to serve

10,000+

standard products

120

countries served

Osborn's first President, Franklin G. Smith, was a stickler for two things: a relentless focus on the customer and implementing a clearly defined strategy for the organization. Being a customer-focused company has allowed us to evolve with the needs of the industries and trades we serve, delivering high-performance products and engineered solutions for our customers' most demanding applications.

We've made significant investments in developing our staff to provide our customers with world-class engineering experts, field service specialists, technical support, and customer service. With offices around the world, we've got the local expertise to collaborate with you on customized products specific to your finishing challenges no matter where you are located.

Why Choose Osborn

When you choose Osborn, you're choosing the industry leader in mechanical surface finishing solutions. Together, we'll collaborate to achieve optimum results, matching tough finishing challenges with the right solutions when and where you need them most.



Innovative and Customized Solutions

As the global leader in surface treatment and finishing solutions, Osborn knows that it's about more than just a product. With Osborn, you have a partner; an expert in your field that is dedicated to providing you the right solutions to do the job at hand **better, faster, and safer.**

Vast Experience

Our approach focuses on vertical markets, including aerospace, agriculture, automotive, construction, energy, medical and pipeline. Our field application experts have years of experience working in these markets and corresponding expertise on the challenges each face.

Shipping in 24 Hours or Less

We understand that time is money, which is why we've developed a strong distribution network that provides their customers with key, premium-quality Osborn products with most popular items shipped within 24 hours.

Table of Contents

Power Brushes

Power Brush Introduction

11–13	
Brushes and Terminology	11–12
Brush Selection Guide.....	13

Wheel Brushes

14–33	
Wheel Brush Selection Guide.....	15
Crimped Wire	16–21
Knot Wire.....	22–27
TY™ Encapsulated Wire.....	28–31
Other Fill	32–33

Cup Brushes

34–44	
Cup Brush Selection Guide.....	35
Crimped Wire	36–37
Knot Wire.....	38–40
TY™ Encapsulated Wire.....	41
High Speed Small Grinder	42–43
Bridled	43
Other Fill	44

End Brushes

45–53	
End Brush Selection Guide	46
Crimped Wire	47–48
Knot Wire.....	49–50
TY™ Encapsulated Wire.....	51
Specialty.....	52
Bridled	53

Internal Brushes

54–65	
Internal Brush Selection Guide.....	55
Internal.....	56–62
Miniature.....	63–65

X-Lock Brushes

66–68	
-------	--

Abrasives

Finding the Right Abrasive Solution	70
Reading the Label.....	71
Cut-off Wheels.....	72–74
Grinding Wheels.....	75–77
Combo Cut/Grind Wheels	78–79
Flap Discs.....	80–83
Polimaxx Polishing Flap Discs.....	84
X-Lock Abrasives	85–87

ATB™ Abrasive Nylon Brushes

ATB™ Introduction & Technical Information	89
ATB™ Nylon Abrasive Filaments.....	89
ATB™ Brush Tool Selection Guide.....	90–92
ATB™ Brush Implementation	93–95
Wheel Brushes	96–100
Disc Brushes	101–105
Disc Brush Bridles.....	106
Uni-Lok® Disc Brush Adapter.....	106
Cup/End Brushes	107–110
Internal Brushes	111–113
Microabrasive Brushes.....	114–115
Miniature Brushes.....	116
NovoFlex Honing Tools	117–120
Softool.....	121
PCD Superabrasives	122–124

Adapters

Slip Fit.....	126
Threaded	126
Bushings.....	127
Arbor Drive	127
CNC.....	127

Maintenance

Maintenance Introduction..... 128
Floor Brooms 130–135
Counter Dusters 136–137
Utility Brushes..... 138–140
Scrub Brushes..... 141–142
Scratch Brushes 143–148

Paint Brushes

Paint Brush Selection Guide..... 150–151
Paint Brush Introduction 152
Paint Brushes 153–160

Polishing

Polishing Introduction..... 162–164
Airway Buffs..... 165
Conventional Buffs 166
Non-Woven/Convolute Wheels..... 167
Flap Brushes and Wheels 168

Index

Alpha Index 169–171
Numerical Index 172–178

How Osborn Can Help Your Business

Osborn has a long tradition, technical expertise, field application knowledge and unparalleled customer service. You can rest assured that you are partnering with the best. We focus on your business's technical challenges and improvement opportunities.



Application Optimization Whether it is a challenging application or an opportunity for process improvement, Osborn field application engineers will work tirelessly to answer your questions and provide you and your company with the most effective solution.



Exclusive Cost Saving Solutions Our teams work directly with distributors and end users to uncover cost-saving solutions without sacrificing on-time delivery.



Troubleshooting Part of Osborn's success is through its people. We make significant investments in training our product specialists so that they are ready and able to answer challenging process and application questions to save you time.



Improved Profitability Osborn understands that the best products are only as good as the solutions they provide. Whether it's uncovering cost reductions, finding ways to lessen setup time, or understanding best cost benefit opportunities for profit growth, Osborn has experts on hand to help you and your customers solve potential profit improvement challenges.

Surfacing Solutions

Osborn offers the best solutions for your mechanical surface treatment challenges. Our experts are highly trained to serve you with the best off-the-shelf or tailored solutions, when and where you need them. Unlike others, we help you optimize your process, meet the highest quality and safety requirements and reduce your costs.



Page Guide

Crimped Wire

Osborn's crimped wire wheel brushes are filled with steel or stainless steel wire in a variety of gauges for applications ranging from aggressive material removal and deburring, to surface conditioning and polishing.

Crimped Wire Wheel Brush with Shank

Featuring our uniform and densely packed TufWire™, Osborn Crimped Wire Wheel Brushes are designed for internal/external cleaning and deburring tasks. These come standard with attached 1/4" diameter shanks for use with die grinders or stationary drill presses.

Applications: Removal of rubber flash, paint slag, scale, rust, surface contamination, weld cleaning, blending, finishing, deburring, descaling, skiving, and pipeline cleaning. Made in the USA.



Safety First!

As a safety precaution, shank must be fully inserted into the chuck or collect and tightened securely.

Brush Diameter	Fill Diameter	Max RPM	Shank Diameter	Trim Length	Item Number
Steel					
1-1/2	0.008	25,000	1/4	9/32	0001646300
1-1/2	0.012	25,000	1/4	9/32	0001646600
1-1/2	0.014	25,000	1/4	9/32	0001646700
1-1/2	0.014	15,000	1/4	1/4	0001650400
2	0.008	25,000	1/4	7/16	0001646800
2	0.008	20,000	1/4	1/2	0001648800
2	0.014	25,000	1/4	7/16	0001647500
2	0.014	18,500	1/4	7/16	0009900100
2	0.020	25,000	1/4	7/16	0001647800
2-1/2	0.008	25,000	1/4	11/16	0001648200
2-1/2	0.014	25,000	1/4	11/16	0001648300
2-1/2	0.020	25,000	1/4	11/16	0001648600
3	0.008	18,500	1/4	11/16	0009900200
3	0.014	25,000	1/4	11/16	0001649600
3	0.014	22,000	1/4	11/16	0009900300
4	0.008	25,000	1/4	1-3/8	0001650200
4	0.020	25,000	1/4	1-3/8	0001650100
Stainless Steel					
1-1/2	0.006	25,000	1/4	9/32	0001655200
1-1/2	0.012	25,000	1/4	9/32	0001655400
2	0.008	25,000	1/4	7/16	0001655500
2	0.014	25,000	1/4	7/16	0001655900
2	0.008	25,000	1/4	11/16	0001656100
2-1/2	0.014	25,000	1/4	11/16	0001656200
3	0.008	25,000	1/4	3/4	0001656500
3	0.008	18,500	1/4	11/16	0009900600
3	0.014	25,000	1/4	11/16	0001656900
3	0.014	18,500	1/4	11/16	0009900700
4	0.008	15,000	1/4	1-7/16	0001657100
4	0.014	15,000	1/4	1-7/16	0001657200
Brass					
3	0.014	25,000	1/4	1	0001649700

Power Brushes

Type of Brush

Colored tabs for easy brush identification

Brush Description

The description helps you quickly find the right brush

Product Specifications

Clearly arranged in tables, all information such as brush diameter, trim length, MSFS (RPM) can be easily found in the table heading

Part Numbers

Our internal 10-digit part number is displayed in a way to assist you with the ordering process

Fill Material

Once you have chosen a product, the tables will be divided by fill material

Brushes Fill Materials

Osborn products only use the finest trim materials developed and tested for maximum performance. Continual testing ensures the highest quality levels.



Steel wire, crimped

- Most common trim material
- For flexible brushing tools
- Suitable for light surface treatment and deburring operations



Tampico fiber

- Pure plant fiber
- For wet and dry cleaning operations
- Heat-resistant
- Suitable for polishing



Steel wire, straight or knotted

- For extreme brushing requirements
- For brushing tools with less flexibility
- Ideal for cleaning weld seams and removing heavy deposits of scale or corrosion

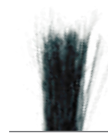

Horse hair

- Animal hair
- For light cleaning operations
- Suitable for sealing



TufWire™ steel wire, crimped or knotted

- Heavy duty steel wire
- Long brush life
- For extreme brushing demands



Synthetic filaments: nylon, polypropylene

- Highly flexible
- Resistant to weak acids and alkaline solutions
- Wear resistant



Stainless steel wire, crimped, straight or knotted

- For use where residue from normal steel wire would contaminate surfaces.

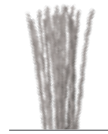

ATB™ nylon abrasive aluminum oxide

- Nylon filaments impregnated with abrasive grit
- Light deburring of steel and non-ferrous metals



Brass wire

- Surface finishing on non-ferrous materials (copper and brass)



ATB™ Ceramic

- Nylon filaments impregnated with abrasive grit
- Aggressive deburring of steel and non-ferrous metals



NovoFlex-B

- Abrasive spheres on a flexible structure
- Self-centering
- Creation of surfaces with a high contact ratio



ATB™ nylon abrasive silicon carbide

- Nylon filaments impregnated with silicon carbide
- Uniform performance as new abrasive particles come to the surface
- High elasticity with no danger of breakage
- Long brush life
- For deburring/descaling, roughening and grinding



Power Brushes

General Information	11–13
Wheel Brushes	14–33
Cup Brushes	34–44
End Brushes	45–53
Internal Brushes	54–65

Brush Terminology

Outside Diameter

The outside diameter, or OD, is the overall size of the brush as measured through the center from two opposite points on the circumference.

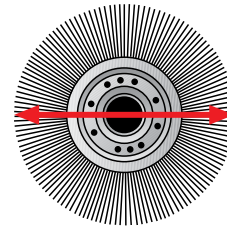

Outside Diameter

Inside Diameter

The inside diameter, or ID, is the diameter of the brush back measured across the center from two opposite points on the flange or plate. (ID should not be confused with the arbor hole, which defines the central opening by which the brush is attached to the tool or machine.)

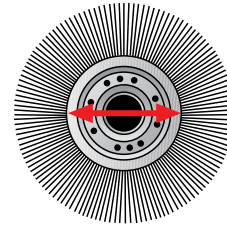

Inside Diameter

Trim Length

Refers to the length of the fill material that extends beyond the brush back or face plates. A short trim makes a stiff, fast-cutting brush, while a long trim gives a brush added flexibility that better enables contact with irregular surfaces.

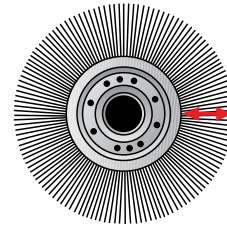

Trim Length

Face Width

The width of the working surface of a wheel brush, comparable to the tread area of a tire. All the face widths shown in this catalog are computed while brushes are in operation.

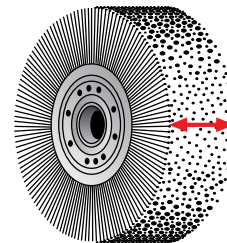

Face Width

Flexibility

Flexibility is the quality of a brush which determines its resiliency and ability to reach into confined areas and conform to uneven or contoured surfaces. It is determined by the overall interaction of inner and outer diameters, trim length, fill density, fill material, and RPM. (Not illustrated here).

Arbor Hole

The diameter of the shaft, spindle, or mandrel which the brush mounts to. (Not illustrated here).

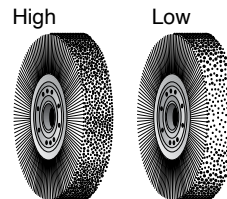

Fill Density

Brushing Speed and Pressure

The RPM speeds shown for Osborn power brushes are Maximum Safe Free Speeds (MSFS). In most operations, a lower speed than MSFS will prove more efficient. Lower speeds and lighter pressures give longer brush life, generate less heat in the work, and require less power.

Where high brush pressures and speeds are required, it is recommended that a more aggressive brush be used. This may be done by increasing wire size and or abrasive grit size, decreasing trim length, or in some instances, changing to another brush type.

Steel Wire Quality

Osborn AB wire is a proprietary product material developed by Osborn and used exclusively for Osborn power brushes. It has outstanding cutting action and excellent fatigue resistance for long, efficient brush life.

Straight wire is used in knot-type brushes and provides maximum impact action for weld cleaning, heavy burr removal, and all jobs requiring fast, aggressive cutting performance.

Crimped wire is used in Osborn conventional brushes of all types: Wheel, cup, end, and internal action. It provides controlled tip action (continuous brushing action) and is excellent for producing fine finishes and removing light burrs.

Knot Types

Standard Twist Knot is good for cleaning grooves, T-connections and weld beads, and for general surface preparation. It is used in all types of wire brushes.

Cable Twist Knot is excellent for standard knot wire applications that need more aggressive action and is most commonly used in wheel brushes.

Stringer Bead Knot is excellent for wheel bead scale removal and root pass applications.

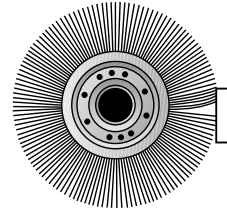

Correct Pressure

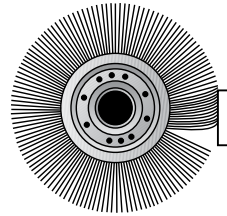

Excessive Pressure



Straight Wire



Brush Selection Guide

Application Guidelines

- Typically the larger the brush diameter, the more efficient the brush.
- To select the maximum allowable size, you must also consider machine speed.
- Brushes do not remove material as cutting tools do; however, they are capable of a variety of functions vital to the manufacturing process.
- Brush type is driven by work to be done, equipment RPM, surface profile.
- Fill material is determined by workpiece material, finish required, equipment RPM.
- Brush size is dependent upon part configuration, finish required, equipment RPM.



The chart below will help you select the most efficient Osborn Power Brush for your work.

	Wheel	Cup	End	Internal
Brightening	●		●	
Buffing	●			
Cleaning	●	●	●	●
Deburring	●	●	●	●
Deflashing	●	●	●	●
Descaling	●	●	●	●
Dusting	●			
Edge Blending	●	●	●	●
Finishing	●	●	●	●
Hose Skiving	●			
Irregular Shapes	●	●	●	
Polishing	●	●	●	●
Roughening	●			
Spot Facing			●	
Stripping	●	●	●	
Surface Prep	●	●	●	
Texturing	●			
Weld Prep	●	●	●	

Wheel Brushes

The most widely used design, the wheel brush, can be mounted either horizontally or vertically, with the tips of the wire doing the actual work as they contact the work piece. Osborn wheel brushes are available in crimped and straight steel, stainless steel and brass wire, plus a variety of natural and synthetic fibers. Brushes with steel and stainless steel wire are also available in encapsulated in TY™ elastomers.

Wheel Brush Selection Guide

Brush Material	Part Type	Aluminum	Brass	Copper	Iron	Plastic	Steel	Stainless Steel	Glass	Wood
Crimped Wire										
Steel		■	■	■	●	—	●	—	■	—
Stainless		◆	■	■	■	—	■	●	■	■
Nonferrous		■	●	●	◆	◆	■	■	■	■
Knotted Wire										
Steel		—	■	■	●	—	●	—	■	—
Stainless Steel		—	■	■	■	—	◆	●	■	—
Nonferrous		◆	●	●	■	◆	■	■	■	—
TY™ Encapsulated Wire										
Standard Duty		—	—	—	●	—	●	●	—	—
Heavy Duty		—	—	—	●	—	●	●	—	—
Natural Fibers										
Tampico-Untreated		◆	◆	◆	■	◆	●	●	■	■
Tampico-Treated		◆	◆	◆	◆	■	●	●	—	■
Synthetics										
Nylon		■	■	■	—	■	■	■	■	■
Polypropylene		■	■	■	—	■	■	■	■	●

● Best Choice ◆ Very Good ■ Suitable — Not Recommended

Crimped Wire

Osborn's crimped wire wheel brushes are filled with steel or stainless steel wire in a variety of gauges for applications ranging from aggressive material removal and deburring, to surface conditioning and polishing.

Crimped Wire Wheel Brush with Shank

Featuring our uniform and densely packed TufWire™, Osborn Crimped Wire Wheel Brushes are designed for internal/external cleaning and deburring tasks. These come standard with attached 1/4" diameter shanks for use with die grinders or stationary drill presses.

Applications: Removal of rubber flash, paint slag, scale, rust, surface contamination, weld cleaning, blending, finishing, deburring, descaling, skiving, and pipeline cleaning. Made in the USA.



Safety First!

As a safety precaution, shank must be fully inserted into the chuck or collet and tightened securely.

Brush Diameter	Fill Diameter	Max RPM	Shank Diameter	Trim Length	Item Number
Steel					
1-1/2	0.008	25,000	1/4	9/32	0001646300
1-1/2	0.012	25,000	1/4	9/32	0001646600
1-1/2	0.014	25,000	1/4	9/32	0001646700
1-1/2	0.014	15,000	1/4	1/4	0001650400
2	0.008	25,000	1/4	7/16	0001646800
2	0.008	20,000	1/4	1/2	0001648800
2	0.014	25,000	1/4	7/16	0001647500
2	0.014	18,500	1/4	7/16	0009900100
2	0.020	25,000	1/4	7/16	0001647800
2-1/2	0.008	25,000	1/4	11/16	0001648200
2-1/2	0.014	25,000	1/4	11/16	0001648300
2-1/2	0.020	25,000	1/4	11/16	0001648600
3	0.008	18,500	1/4	11/16	0009900200
3	0.014	25,000	1/4	11/16	0001649600
3	0.014	22,000	1/4	11/16	0009900300
4	0.008	25,000	1/4	1-3/8	0001650200
4	0.020	25,000	1/4	1-3/8	0001650100
Stainless Steel					
1-1/2	0.006	25,000	1/4	9/32	0001655200
1-1/2	0.012	25,000	1/4	9/32	0001655400
2	0.008	25,000	1/4	7/16	0001655500
2	0.014	25,000	1/4	7/16	0001655900
2	0.008	25,000	1/4	11/16	0001656100
2-1/2	0.014	25,000	1/4	11/16	0001656200
3	0.008	25,000	1/4	3/4	0001656500
3	0.008	18,500	1/4	11/16	0009900600
3	0.014	25,000	1/4	11/16	0001656900
3	0.014	18,500	1/4	11/16	0009900700
4	0.008	15,000	1/4	1-7/16	0001657100
4	0.014	15,000	1/4	1-7/16	0001657200
Brass					
3	0.014	25,000	1/4	1	0001649700

Crimped Wire Radial Section–Light Duty

Designed for flexibility to provide a soft brushing action, Osborn Crimped Wire Radial Sections are ideal for the cleaning of irregular shaped parts. Our proprietary wire design allows for thorough cleaning without risking damage to fragile pieces. Made in the USA.



Brush Diameter	Fill Diameter	Arbor Hole Diameter	Max RPM	Trim Length	Face Width	Item Number
Steel						
6	0.006	2	4,000	1-5/8	5/8	0002107100
10	0.020	4-1/4	3,250	2-1/2	1/2	0002196200
Stainless Steel						
4	0.005	1-1/4	6,000	1-3/16	3/8	0002107600
6	0.005	2	4,000	1-5/8	1/2	0002107700
10	0.005	2	3,250	3-5/8	1/2	0002107800

Crimped Wire Narrow Face Wheel Brush

Designed to clean and deburr the narrowest of areas, Osborn Crimped Wire Narrow Face Wheel Brushes offer a flexible solution for a variety of spaces. These brushes can also be mounted in multiples to tackle wider surfaces to remove paint or produce antique finishes. All varieties feature Osborn's proprietary TufWire™ to ensure uniform performance and extended lifespan.

Note that all 3/8"–5/8" and 1/2"–5/8" arbor holes are supplied with a removable adapter.

Applications: Removal of rubber flash, paint slag, scale, rust, surface contamination, weld cleaning, blending, finishing, deburring, descaling, and skiving. Made in the USA.



Brush Diameter	Fill Diameter	Arbor Hole Diameter	Max RPM	Trim Length	Face Width	Item Number
Steel						
4	0.006	5/8	6,000	13/16	5/8	0002159100
4	0.010	5/8	6,000	13/16	5/8	0002100300
4	0.010	5/8	6,000	13/16	5/8	0002159200
4	0.012	5/8	6,000	13/16	5/8	0002159300
4	0.014	5/8	6,000	7/8	3/8	0002100700
4	0.014	5/8	6,000	11/16	5/8	0009900800
6	0.006	1-1/4	6,000	1-1/8	5/8	0002100900
6	0.006	5/8	6,000	1-1/8	5/8	0002158300
6	0.008	1-1/4	6,000	1-1/8	5/8	0002101300
6	0.008	5/8	6,000	1-1/8	5/8	0002158400
6	0.010	1-1/4	6,000	1-1/8	5/8	0002101600
6	0.010	5/8	6,000	1-1/8	5/8	0002158500
6	0.012	5/8	6,000	1-1/8	5/8	0002158600
6	0.014	1-1/4	6,000	1-1/8	5/8	0002102000
6	0.014	5/8	6,000	1-1/8	5/8	0002158700
6	0.014	5/8	6,000	1-1/8	5/8	0009900900
8	0.006	1-1/4	4,500	1-1/2	5/8	0002118200
8	0.010	1-1/4	4,500	1-1/2	5/8	0002103100
8	0.012	1-1/4	4,500	1-1/2	5/8	0002118800
8	0.014	1-1/4	4,500	1-1/2	5/8	0002103300
8	0.014	5/8	4,500	1-37/64	5/8	0009901000
10	0.008	2	3,600	2-1/2	5/8	0002106700
10	0.010	1-1/4	3,600	2-1/2	5/8	0002120100
10	0.014	1-1/4	3,600	2-1/2	5/8	0002104100
12	0.005	1-1/4	3,000	3	1	0002104700
12	0.006	2	3,000	3	1	0002105000
12	0.010	1-1/4	3,000	3	1/2	0002104400
12	0.010	1-1/4	3,000	3	1	0002105100
12	0.010	2	3,000	3	1	0002105200



Use with 1-1/4" or 2" arbor hole adapters which are available to meet your machine requirements page 126.

Continued on next page

Crimped Wire Narrow Face Wheel Brush *Continued*

Brush Diameter	Fill Diameter	Arbor Hole Diameter	Max RPM	Trim Length	Face Width	Item Number
Stainless Steel						
4	0.006	5/8	6,000	7/8	5/8	0002100600
4	0.010	5/8	6,000	13/16	3/8	0002159700
4	0.014	5/8	6,000	7/8	3/8	0002100800
6	0.005	1-1/4	6,000	1-1/8	5/8	0002105600
6	0.010	1-1/4	6,000	1-1/8	5/8	0002105900
6	0.010	5/8	6,000	1-1/8	5/8	0002158800
8	0.005	1-1/4	4,500	1-1/2	3/4	0002119500
8	0.010	1-1/4	4,500	1-1/2	3/4	0002106100
8	0.014	1-1/4	4,500	1-1/2	5/8	0002101100
12	0.010	2	3,000	3	1	0002106300
Brass						
6	0.014	1-1/4	6,000	1-1/8	5/8	0002104600



Crimped Wire Medium Face Wheel Brush

Constructed of Osborn's proprietary TufWire™, Crimped Wire Medium Face Wheel Brushes are flexible, yet aggressive to tackle a variety of tasks with ease. Can be used individually or mounted in multiples for addressing wide areas. The unique design of TufWire™ also ensures an exceptionally long brush life with consistent performance from start to finish.

Applications: Edge blending, deburring, rust removal, surface finishing, general bench motor use. Made in the USA.



Brush Diameter	Fill Diameter	Arbor Hole Diameter	Max RPM	Trim Length	Face Width	Item Number
Steel						
4	0.008	3/4	6,000	7/8	5/8	0009901100
4	0.014	3/4	6,000	7/8	5/8	0009901400
4-1/4	0.012	2	6,000	11/16	5/8	0002204500
6	0.006	2	6,000	1	7/8	0002206100
6	0.008	2	6,000	1	7/8	0002206200
6	0.008	2	6,000	1	45/64	0009901200
6	0.010	2	6,000	1	7/8	0002206400
6	0.012	2	6,000	1	7/8	0002206500
6	0.014	2	6,000	1	7/8	0002206600
6	0.014	2	6,000	1	45/64	0009901500
7	0.010	2	6,000	1-1/2	3/4	0002207400
7	0.014	2	6,000	1-1/2	3/4	0002207600
7	0.014	2	6,000	1-1/64	25/32	0009901600
8	0.006	2	4,500	1-1/2	7/8	0002208100
8	0.008	1-1/4	4,500	1-1/2	7/8	0002102400
8	0.008	2	4,500	1-1/2	7/8	0002208200
8	0.008	2	4,500	1-5/16	25/32	0009901300
8	0.012	2	4,500	1-1/2	7/8	0002208500
8	0.012	1-1/4	4,500	1-1/2	7/8	0002209400
8	0.014	2	4,500	1-1/2	7/8	0002208600
8	0.014	1-1/4	4,500	1-1/2	7/8	0002209500
8	0.014	2	4,500	1-5/16	25/64	0009901700
8	0.020	2	4,500	1-1/2	7/8	0002208700
10	0.008	2	3,600	2	1-1/4	0002210900
10	0.010	2	3,600	2	1-1/4	0002211000
10	0.012	2	3,600	2	1-1/4	0002211100
10	0.014	2	3,600	2	1-1/4	0002211200
10	0.020	2	3,600	2	1-1/4	0002211400
12	0.008	2	3,000	1-7/8	1-1/4	0002213700
12	0.010	2	3,000	1-7/8	1-1/4	0002213800
12	0.012	2	3,000	3	1-1/8	0002212500
12	0.012	2	3,000	1-7/8	1-1/4	0002213900
12	0.014	2	3,000	3	1-1/8	0002212600
12	0.014	2	3,000	1-7/8	1-1/4	0002214000
12	0.020	2	3,000	1-7/8	1-1/4	0002214200
15	0.012	2	2,400	2-3/4	1-3/8	0002227400

Did you know? As a power brush is used, the wire tips wear down to a point and naturally sharpen. When using a wire wheel with a non-threaded arbor hole, you can **flip the brush 180*** and remount to fully take advantage of the self-sharpened wire tips.

Continued on next page

Crimped Wire Medium Face Wheel Brush *Continued*

Brush Diameter	Fill Diameter	Arbor Hole Diameter	Max RPM	Trim Length	Face Width	Item Number
Stainless Steel						
6	0.008	2	6,000	1	7/8	0002214600
6	0.012	2	6,000	1	7/8	0002215100
6	0.014	2	6,000	1	7/8	0002214700
8	0.008	2	4,500	1-1/2	7/8	0002214800
8	0.012	2	4,500	1-1/2	7/8	0002214900
8	0.014	2	4,500	1-1/2	7/8	0002215000
10	0.006	2	3,600	2	1-1/4	0002210800
12	0.014	2	3,000	3	1-1/8	0002205200

Crimped Wire Wide Face Wheel Brush

Combining Osborn's proprietary TufWire™ construction with a wider face width, Crimped Wire Wide Face Wheel Brushes provide quick, efficient brushing on production work and general maintenance tasks. As with all Osborn TufWire™ products, brushes are designed for consistent performance and longevity to save you time and money. Wheels fit directly onto 2" diameter arbors without adapters. Use of the adapter kit is required for other arbor sizes.

Applications: Deburring, rust removal, surface finishing, general cleanup. Made in the USA.



Brush Diameter	Fill Diameter	Arbor Hole Diameter	Max RPM	Trim Length	Face Width	Item Number
Steel						
4	0.014	3/4	6,000	13/16	1	0009902100
4-1/4	0.012	2	6,000	3/4	1	0002200300
4-1/4	0.014	2	6,000	3/4	1	0002200400
6	0.006	2	6,000	1	1-1/4	0002200500
6	0.008	2	6,000	1	1-1/4	0002200600
6	0.008	2	6,000	1	1	0009901900
6	0.010	2	6,000	1	1-1/4	0002206000
6	0.012	2	6,000	1	1-1/4	0002200700
6	0.014	2	6,000	1	1-1/4	0002200800
6	0.014	2	6,000	1	1-1/8	0009902200
8	0.006	2	4,500	1-1/2	1-1/2	0002201000
8	0.008	2	4,500	1-1/2	1-1/2	0002202500
8	0.010	2	4,500	1-1/2	1-1/2	0002208000
8	0.012	2	4,500	1-1/2	1-1/2	0002202600
8	0.014	2	4,500	1-1/2	1-1/2	0002201200
8	0.014	2	4,500	1-5/16	1	0009902300
8	0.020	2	4,500	1-1/2	1-1/2	0002201300
10	0.010	2	3,600	2-1/8	2	0002201400
10	0.012	2	3,600	2-1/8	2	0002203000
10	0.014	2	3,600	2-1/8	2	0002202900
10	0.020	2	3,600	2-3/16	2	0002201500
12	0.012	2	3,600	3-1/4	2	0002201600
12	0.014	2	3,600	3-1/4	2	0002203800
12	0.020	2	3,600	3-3/16	2	0002201700
12	0.020	2	3,000	1-7/8	2	0002222500
15	0.012	2	2,400	3-3/8	2-1/4	0002201800
Stainless Steel						
6	0.008	2	6,000	1-1/16	1-1/4	0002210000
6	0.010	2	6,000	1-1/16	1-1/2	0002200900
6	0.014	2	6,000	1	1-1/4	0002210100
8	0.012	2	4,500	1-1/2	1-1/2	0002210300
8	0.020	2	4,500	1-1/2	1-1/2	0002210400

Ringlock Wire Wheel Brush

Specially designed to brush down-hole, internal surfaces and other hard-to-reach areas. Designed with Osborn's proprietary TufWire™ wire strands to provide effective brushing, this product can be mounted singly or in multiples, directly onto the shaft of a portable tool to accommodate a wide variety of tasks.

Applications: ID cleaning, deburring, rust, scale, carbon and corrosion removal. Made in the USA.



Use centering bushing to fit different arbor sizes
page 127.

Brush Diameter	Fill Diameter	Arbor Hole Diameter	Max RPM	Trim Length	Face Width	Item Number
Steel						
1	0.008	3/16	20,000	11/64	5/32	0001100400
1-1/4	0.008	3/8	20,000	1/4	7/32	0001101000
1-1/4	0.010	3/8	20,000	1/4	7/32	0001101100
1-1/4	0.014	3/8	20,000	1/4	1/4	0001101200
1-3/8	0.006	1/4	20,000	25/64	3/16	0001101300
1-3/8	0.008	1/4	20,000	25/64	3/16	0001101400
1-3/8	0.010	1/4	20,000	25/64	3/16	0001101500
1-1/2	0.006	3/8	20,000	3/8	7/32	0001101600
1-1/2	0.008	3/8	20,000	3/8	7/32	0001101700
1-1/2	0.010	3/8	20,000	3/8	7/32	0001101800
1-1/2	0.014	3/8	20,000	3/8	7/32	0001101900
2	0.003	1/2	20,000	9/16	1/4	0001102900
2	0.006	1/2	20,000	9/16	1/4	0001103100
2	0.008	1/2	20,000	1/2	1/4	0001103200
2	0.012	1/2	20,000	1/2	1/4	0001103300
2	0.014	3/8	20,000	7/16	1/4	0001102800
2	0.014	1/2	20,000	1/2	1/4	0001103400
2-1/2	0.006	1/2	20,000	3/4	1/4	0001104500
2-1/2	0.008	1/2	20,000	3/4	1/4	0001104600
2-1/2	0.012	5/8	20,000	11/16	9/32	0001105100
2-1/2	0.014	1/2	20,000	3/4	1/4	0001104800
2-1/2	0.014	5/8	20,000	11/16	9/32	0001105200
2-3/4	0.005	5/8	20,000	3/4	3/8	0001611900
3	0.006	5/8	20,000	15/16	3/8	0001106100
3	0.008	1/2	20,000	1	1/4	0001105800
3	0.008	5/8	20,000	15/16	3/8	0001106200
3	0.014	3/8	20,000	15/16	3/8	0001105600
3	0.014	1/2	20,000	1	1/4	0001106000
3	0.014	5/8	20,000	15/16	3/8	0001106300
4	0.008	5/8	20,000	1-1/2	3/16	0001106500
4	0.014	5/8	15,000	1-1/2	3/16	0001106600
5	0.005	1-1/4	20,000	1-9/16	1/4	0001613900
Stainless Steel						
1	0.003	1/4	20,000	13/64	3/16	0001107000
1-1/4	0.005	1/4	20,000	21/64	3/16	0001107300
1-1/2	0.005	3/8	20,000	3/8	7/32	0001107800
2	0.005	1/2	20,000	1/2	1/4	0001108600
2	0.010	1/2	20,000	1/2	1/4	0001108800
2	0.014	1/2	20,000	1/2	1/4	0001100800
2	0.014	3/8	20,000	7/16	9/32	0001108500
3	0.005	1/2	20,000	1	1/4	0001109400
3	0.008	1/2	20,000	1	1/4	0001109500
3	0.014	3/8	20,000	15/16	3/8	0001109300
3	0.014	1/2	20,000	1	1/4	0001109700
3	0.014	5/8	20,000	15/16	3/8	0001110100
3	0.014	3/8	20,000	15/16	3/8	0001111100
Brass						
2	0.005	3/8	20,000	1	3/16	0001627800
2	0.005	1/2	20,000	1/2	1/4	0001629400
4	0.005	5/8	20,000	1/2	1/4	0001629500

Crimped High Speed Small Grinder Wire Wheel Brush

Osborn's Crimped High Speed Small Grinder Wire Wheel Brush are ideal for light duty cleaning and finishing applications. Our proprietary wire design ensures consistent, thorough cleaning and longevity. For use with portable air and electric tools. Made in the USA.



Brush Diameter	Fill Diameter	Arbor Hole Diameter	Max RPM	Trim Length	Item Number
Steel					
4	0.014	5/8-11	15,000	7/8	0002130000
4	0.014	1/2-13	15,000	7/8	0002130300
4	0.014	5/8-11	15,000	7/8	0002130400
4	0.014	5/8-11	15,000	7/8	0009909400
4	0.020	5/8-11	15,000	7/8	0009909500
Stainless Steel					
4	0.006	5/8-11	15,000	7/8	0002108200*
4	0.014	5/8-11	15,000	7/8	0002130900
4	0.014	5/8-11	15,000	7/8	0009909600

* 316 Stainless Steel

Knot Wire Wheel Brushes

Rugged knot-type construction provides high brush flexibility, more uniform results, maximum safety and efficient operation at high speeds. Brushes larger than 6" should be mounted on tables; those 6" and smaller can be mounted to stationary installations or attached to portable tools.

Knot Wire Wheel Brush

Featuring Osborn's proprietary TufWire™ wire strands and rugged knot-type construction, Osborn Knot Wire Wheel Brushes provide more brush flexibility to deliver more uniform results. The design also ensures maximum safety and efficient operation at high speeds, making them ideal for a wide variety of projects.

Applications: Cleans grooves, t-connections, welded beads and surface preparation. Made in the USA.



Brush Diameter	Fill Diameter	Arbor Hole Diameter	Max RPM	Trim Length	Face Width	Item Number
Steel						
3	0.014	3/8	25,000	5/8	3/8	0002692700
3	0.014	1/2	25,000	5/8	3/8	0009906600
3	0.020	3/8	25,000	5/8	3/8	0002692800
4	0.012	5/8	20,000	7/8	5/16	0002602800
4	0.014	3/8	20,000	7/8	5/16	0002601700
4	0.014	5/8	20,000	7/8	5/16	0002602900
4	0.014	5/8	20,000	7/8	5/16	0002630200
4	0.020	5/8	20,000	7/8	5/16	0002603000
4	0.020	5/8-11	20,000	3/4	3/8	0002696400
5	0.020	5/8-11	12,000	1-1/16	3/16	0009907100
6	0.010	5/8	9,000	1-1/2	1/2	0002604000
6	0.012	5/8	9,000	1-1/2	1/2	0002604100
6	0.014	5/8	9,000	1-1/2	1/2	0002604200
6	0.014	5/8-11	9,000	1-1/2	1/2	0002630600
6	0.016	5/8	9,000	1-1/2	1/2	0002604300
6	0.020	5/8-1/2	9,000	1-1/32	1/2	0009907300
6	0.020	5/8-11	9,000	1-1/32	1/2	0009913000
6	0.023	5/8	9,000	1-1/2	1/2	0002604600
6	0.023	5/8-11	9,000	1-1/2	1/2	0002604700
6-1/2	0.023	5/8-11	12,000	1-1/4	3/8	0002603900
7	0.012	5/8	9,000	1-3/4	5/8	0002605000
8	0.012	5/8	8,500	1-11/16	5/8	0002605800
8	0.012	1-1/4	8,500	1-11/16	5/8	0002606400
8	0.014	5/8	8,500	1-11/16	5/8	0002605900
8	0.014	1-1/4	8,500	1-11/16	5/8	0002606500
8	0.016	5/8	8,500	1-11/16	5/8	0002606000
8	0.020	1-1/4	8,500	1-11/16	5/8	0009907500
8	0.023	5/8	8,500	1-11/16	5/8	0002606100
8	0.023	5/8-11	8,500	1-11/16	5/8	0002606200
8	0.023	1-1/4	8,500	1-11/16	5/8	0002606700
10	0.012	1-1/4	4,500	2-1/4	5/8	0002607000
10	0.014	1-1/4	4,500	2-1/4	5/8	0002607100
10	0.016	1-1/4	4,500	2-1/4	5/8	0002607200
12	0.012	1-1/4	4,500	3-1/4	5/8	0002607500
12	0.016	2	4,500	3-1/4	5/8	0002608100

Continued on next page

Knot Wire Wheel Brush *Continued*

Brush Diameter	Fill Diameter	Arbor Hole Diameter	Max RPM	Trim Length	Face Width	Item Number
Stainless Steel						
3	0.014	3/8	25,000	5/8	3/8	0002620600
3	0.014	1/2	25,000	37/64	3/8	0009907600
4	0.014	3/8	20,000	7/8	5/16	0002620900
4	0.014	1/2	20,000	7/8	5/16	0002621000
4	0.014	5/8	20,000	7/8	5/16	0002634200
4	0.014	5/8	20,000	25/32	5/16	0009907700
5	0.020	5/8-11	12,000	1-17/64	3/16	0009907800
6	0.014	5/8-11	9,000	1-3/8	1/2	0009907900
6	0.016	5/8-11	9,000	1-1/2	1/2	0002603800
6	0.016	5/8	9,000	1-1/2	1/2	0002622500
6	0.023	5/8-11	9,000	1-1/2	1/2	0002634600
8	0.016	5/8	8,500	1-11/16	5/8	0002623000
8	0.016	1-1/4	8,500	1-11/16	5/8	0002623100
Brass						
4	0.014	5/8	20,000	7/8	5/16	0002609300



Knot Wire Wheel Brush with Shank

Designed to operate efficiently at high speeds, Osborn's standard twist Knot Wire Wheels with Shank are ideal for a wide range of applications. Constructed of our proprietary TufWire™, these brushes thoroughly clean metal and other surfaces and are designed for long-term use. All brushes have a 1/4" shank.

Applications: Maintenance, metal surface cleaning. Made in the USA.

Brush Diameter	Fill Diameter	Max RPM	Trim Length	Item Number
Steel				
3	0.014	25,000	5/8	0002618600
3	0.020	25,000	5/8	0002618700
4	0.014	20,000	7/8	0002618900
4	0.020	20,000	7/8	0002619000
Stainless Steel				
3	0.014	25,000	5/8	0002618800
4	0.014	20,000	7/8	0002619100



Safety First!

As a safety precaution, shank must be fully inserted into the chuck or collect and tightened securely.

Problem

Smoother finish required



Solution

- Increase surface speed
- Decrease trim length
- Increase wire diameter
- Use a TY™ encapsulated brush

Brush not aggressive enough



- Increase surface speed
- Decrease trim length
- Increase wire diameter

Knot Wire Wheel Brush—Heavy Duty

Tough jobs call for a harder-working design. Osborn heavy duty Knot Wire Wheel Brushes feature our proprietary TufWire™ for increased aggressiveness and longevity. It's slightly wider face and tighter knots effectively tackle difficult tasks such as deflashing/cleaning motor mounts, cleaning foundry molds, weld prep/cleaning, removing heavy surface contamination, heavy-duty deburring and pipeline cleaning. Larger sizes have a shorter trim length for added rigidity.

Applications: Deflashing and cleaning motor mounts, cleaning foundry molds, weld prep and cleaning, removing heavy surface contamination, pipeline cleaning, heavy duty deburring. Made in the USA.



Brush Diameter	Fill Diameter	Arbor Hole Diameter	Max RPM	Trim Length	Face Width	Item Number
Steel						
3	0.020	3/8	25,000	11/16	3/8	0002600600
3-1/8	0.012	3/8	25,000	11/16	3/8	0002600400
3-1/8	0.014	3/8	25,000	11/16	3/8	0002600500
4	0.012	5/8	18,000	7/8	1/2	0002611500
4	0.012	1/2	20,000	7/8	1	0002625000
4	0.014	3/8	18,000	7/8	1/2	0002610400
4	0.014	5/8	18,000	7/8	1/2	0002611600
4	0.020	5/8	18,000	7/8	1/2	0002611700
6	0.012	5/8	9,000	1-1/2	1/2	0002612100
6	0.014	5/8	9,000	1-1/2	1/2	0002612200
8	0.012	5/8	8,000	1-11/16	5/8	0002612900
8	0.020	2	8,000	1-11/16	5/8	0002624000
10	0.014	1-1/4	4,500	1-3/4	1/2	0002613500
10	0.020	1-1/4	4,500	1-3/4	1/2	0002613700
10	0.020	2	4,500	1-3/4	1/2	0002618500
12	0.014	1-1/4	5,000	2-1/4	1/2	0002623400
12	0.020	1-1/4	5,000	2-1/4	1/2	0002623500
12	0.020	2	5,000	2-1/4	1/2	0002623600
15	0.020	1-1/4	5,000	2-5/8	1/2	0002616200
15	0.020	2	5,000	2-5/8	1/2	0002616700
Stainless Steel						
3-1/8	0.014	3/8	25,000	11/16	3/8	0002620400
4	0.014	3/8	18,000	7/8	1/2	0002621600
4	0.014	5/8	18,000	7/8	1/2	0002621800

Knot Wire Wheel Brush—Extra Heavy Duty

Tackle the toughest jobs with Osborn's extra heavy duty Knot Wire Wheel Brush. Brushes feature our proprietary TufWire™, which is 2–3 times more aggressive than standard carbon steel wire in competitors' brushes and provides unmatched longevity. TufWire™, along with the rugged, tight cross-section profile of the brush, makes quick work of demanding tasks such as gear deburring, pipeline cleaning, rust removal, and weld cleaning. For use with automatic/semi-automatic equipment or off-hand work.

Applications: Gear deburring, pipeline cleaning, removing rust, scale, rubber flash, deburring, weld cleaning. Made in the USA.



Brush Diameter	Fill Diameter	Arbor Hole Diameter	Max RPM	Trim Length	Face Width	Item Number
Steel						
6	0.012	5/8	9,000	1-1/4	5/8	0002609800
8	0.012	2	8,000	1-1/4	5/8	0002609900
12	0.012	2	5,000	1-1/8	1/2	0002610100
14	0.012	2	5,000	2-1/8	1/2	0002615500
14	0.014	2	5,000	2-1/8	1/2	0002615700
14	0.016	1-1/4	5,000	2-1/8	1/2	0002615800
14	0.016	2	5,000	2-1/8	1/2	0002615900

Knot Wire Wheel Brush–Wide Face, Heavy Duty

Osborn's wide face, extra heavy duty Wire Wheel Brush features a cable twist knot wide brush face that is especially suited for drawing welding wire. Constructed with our proprietary TufWire™ for unmatched aggressiveness and rigidity, this brush strips carbon deposits, scale and rust quickly and effectively from the wire to prevent damage to wire drawing machinery. Made in the USA.



Brush Diameter	Fill Diameter	Arbor Hole Diameter	Max RPM	Trim Length	Face Width	Item Number
Steel						
10	0.020	2	4,500	1-3/4	1-3/4	0002686700

High Speed Small Grinder Knot Wire Wheel Brush

Quickly clean grooves, T-connections, welded beads and more with Osborn's High Speed Small Grinder Knot Wire Wheel Brush. Featuring our proprietary TufWire™ wire strands and rugged knot design, this versatile brush delivers uniform results from start to finish. Brush is designed for maximum safety and smooth, efficient operation at high speeds on air tools or portable power tools.

Applications: Cleans grooves, t-connections, welded beads and surface preparation. Made in the USA.



Brush Diameter	Fill Diameter	Arbor Hole Diameter	Max RPM	Trim Length	Item Number
Steel					
4	0.014	M14-2	20,000	7/8	0002635500
4	0.014	1/2-13	20,000	7/8	0002635800
4	0.014	5/8-11	20,000	7/8	0002635900
4	0.014	3/8-24	20,000	7/8	0002636000
4	0.020	1/2-13	20,000	7/8	0002639100
4	0.020	5/8-11	20,000	7/8	0002639200
4	0.020	5/8-11	20,000	57/64	0009906900
5	0.020	5/8-11	12,000	1	0002621300
Stainless Steel					
4	0.014	1/2-13	20,000	7/8	0002637500
4	0.014	5/8-11	20,000	7/8	0002637600
4	0.014	3/8-24	20,000	7/8	0002637700
4	0.020	1/2-13	20,000	7/8	0002638500
4	0.020	5/8-11	20,000	7/8	0002638600
5	0.020	5/8-11	12,000	1	0002621400
Brass					
4	0.014	5/8-11	20,000	7/8	0002609400

Stringer Bead Brush

Enjoy American-made quality and performance at an economical price. Features Osborn's proprietary TufWire™ wire strands, which outperform competitive products in both material removal and longevity. Works aggressively on a variety of jobs using air tools or portable tools.

Applications: Bead scale removal, surface preparation, pipe joining. Made in the USA.



Brush Diameter	Fill Diameter	Arbor Hole Diameter	Knot Count	Max RPM	Trim Length	Face Width	Item Number
Steel							
4	0.020	3/8-24	30	20,000	7/8	1/4	0002636300
4	0.020	5/8-11	30	20,000	7/8	1/4	00099082B0R
5	0.020	5/8-11	30	12,000	25/32	3/16	0009908300
6-1/2	0.020	5/8-11	48	12,000	1-7/32	1/4	0002604800
6-1/2	0.020	5/8-11	60	12,000	1-1/4	3/16	0002608800
6-1/2	0.020	5/8-11	48	12,000	1-25/64	3/16	0009908600
6-3/4	0.020	5/8-11	76	8,000	1-1/8	3/16	0002690400
7	0.020	5/8-11	56	9,000	1-1/8	3/16	0002684200
Stainless Steel							
4	0.020	M10-1.25	30	20,000	7/8	1/4	0002639600
4	0.020	1/2-13	30	20,000	7/8	1/4	0002639800
4	0.020	3/8-24	30	20,000	7/8	1/4	0002640000
4	0.020	5/8-11	30	20,000	7/8	5/16	00099088B0R
4-7/8	0.020	5/8-11	48	12,000	1	3/8	0002646800
6-1/2	0.020	5/8-11	48	12,000	1-7/32	1/4	0002622600
6-1/2	0.020	5/8-11	60	12,000	1-1/4	3/16	0002634700
7	0.020	5/8-11	56	9,000	1-1/8	3/16	0002687500

TufBrush Stringer Bead Brush

Trust Osborn TufBrush™ products to get the toughest jobs done quickly and efficiently. Osborn's unique design starts with quality wire. TufWire™, our proprietary wire strands, offers increased rigidity and aggressiveness. Combined with a unique knot design, TufBrush™ products consistently remove 60% more material than standard carbon steel wire varieties. Because of the brush's state-of-the-art design, TufBrush products last twice as long as commodity brushes, which means less replacements and less downtime.

Applications: Weld clean up, surface preparation, pipe joining. Made in the USA.



Brush Diameter	Fill Diameter	Arbor Hole Diameter	Knot Count	Max RPM	Trim Length	Face Width	Item Number
Steel							
4	0.020	5/8-11	32	20,000	7/8	1/8	0002636900
4-1/2	0.020	5/8-11	32	20,000	7/8	1/8	0002323000
5	0.020	5/8-11	48	12,000	1	3/16	0002649500
6	0.020	5/8-11	48	12,000	1-1/2	3/16	0002603200
Stainless Steel							
4	0.020	5/8-11	32	20,000	7/8	1/8	0002639900
4-1/2	0.020	5/8-11	32	20,000	7/8	1/8	0002323900
5	0.020	5/8-11	48	12,000	1	3/16	0002634400
6	0.020	5/8-11	48	12,000	1-1/2	3/16	0002611200

It's not just a brush, it's an investment

- Aggressive knot design features 32 knots
- Boasts 30 TufWire™ wire strands per knot
- Tightest knot specification in the market

High Speed Small Grinder Cable Knot Wheel Brush

Featuring Osborn's proprietary TufWire™ wire strands and cable twist knots, our High Speed Small Grinder Cable Knot Wheel Brushes are designed to tackle applications that need more aggressive action than standard knot wire brushes can offer. Premium rigid wire provides efficient and uniform cleaning and coating removal. Made in the USA.



Brush Diameter	Fill Diameter	Arbor Hole Diameter	Max RPM	Trim Length	Item Number
Steel					
4	0.020	5/8-11	20,000	7/8	0002645500
4	0.020	5/8-11	20,000	25/32	0009909200
4	0.020	5/8-11	12,500	7/8	0009906000
5	0.020	5/8-11	12,500	1-1/64	0009906200
Stainless Steel					
4	0.020		20,000	7/8	0002646100
4	0.020	5/8-11	20,000	25/32	0009909300

Cement Cleaning Brush

Designed with heavy-duty cable twist TufWire™ wire strands and a longer trim length, Osborn Cement Cleaning Brushes thoroughly remove joint material from concrete and asphalt.

Applications: Removal of joint material from concrete and asphalt, penetration of expansion joints. Made in the USA.



Brush Diameter	Fill Diameter	Arbor Hole Diameter	Max RPM	Item Number
Steel				
10	0.023	1	8,500	0002725000
12	0.035	1	6,000	0002722800

TY™ Encapsulated Wheel Brushes

Osborn TY™ Encapsulated Brushes feature an elastomer which firmly supports the individual wire tips, producing stronger brushing action and longer life. In use, the elastomer wears back gradually, presenting a constant short wire trim for maximum cut. These wheels can be used singularly or mounted in multiples to create a wider brushing face.

Reasons to use TY™:

- **Safety**—encapsulation minimizes wire breakage
- **More aggressive**—encapsulation allows only the tips of the wire to be exposed, minimizing flexibility and therefore maximizing aggression.
- **Longer lasting**—since flexibility is minimized, wire lifespan is longer

TY™ Encapsulated Wheel Brush—Narrow Face, Standard Duty

Safely remove paint/coatings, busbar insulation and hose skiving with Osborn's versatile narrow face, standard duty TY™ Encapsulated Wheel Brush. Made in the USA.

Brush Diameter	Fill Diameter	Arbor Hole Diameter	Max RPM	Trim Length	Face Width	Item Number
Steel						
4	0.010	5/8	6,000	3/4	3/8	0002159500
6	0.006	1-1/4	6,000	1-1/8	3/8	0002150300
6	0.008	1-1/4	6,000	1-1/8	3/8	0002150400
6	0.010	1-1/4	6,000	1-1/8	3/8	0002150600
6	0.014	1-1/4	6,000	1-1/8	3/8	0002150800
8	0.008	1-1/4	4,500	1-1/2	3/8	0002150900
8	0.010	1-1/4	4,500	1-1/2	3/8	0002151200
10	0.010	1-1/4	3,600	2-1/2	3/8	0002155700
Stainless Steel						
6	0.010	1-1/4	6,000	1-1/8	3/8	0002152800



TY™ Encapsulated Wheel Brush—Narrow Face, Heavy Duty

Safely remove paint/coatings, busbar insulation and hose skiving with Osborn's versatile narrow face, standard duty TY™ Encapsulated Wheel Brush.

Applications: Offhand deburring, weld cleaning. Made in the USA.

Brush Diameter	Fill Diameter	Arbor Hole Diameter	Max RPM	Trim Length	Face Width	Item Number
Steel						
8	0.010	1-1/4	4,500	1-1/2	17/32	0002154000



TY™ Encapsulated Wheel Brush–Wide Face, Standard Duty

Safely remove paint/coatings, busbar insulation and hose skiving on larger surfaces with Osborn's wide face, standard duty TY™ Encapsulated Wheel Brush.

Brush Diameter	Fill Diameter	Arbor Hole Diameter	Max RPM	Trim Length	Face Width	Item Number
Steel						
4-1/4	0.012	2	6,000	3/4	7/8	0002270100
6	0.012	2	6,000	1-1/8	1	0002270400



TY™ Encapsulated Wheel Brush–Wide Face, Heavy Duty

Osborn's wide face, heavy duty TY™ Encapsulated Wheel Brush features maximum aggression for tougher applications, such as off-hand deburring and weld cleaning. Because wire is encapsulated, long wire breakage is minimized. Wide face covers larger surface areas quickly and efficiently.

Applications: Rubber flash removal. Made in the USA.

Brush Diameter	Fill Diameter	Arbor Hole Diameter	Max RPM	Trim Length	Face Width	Item Number
Steel						
6	0.014	2	6,000	1	1	0002271800



TY™ Encapsulated Wheel Brush–Medium Face, Standard Duty

Safely remove rubber flashing and more with Osborn's TY™ Encapsulated Wheel Brush. Can be used singly or mounted in multiples to tackle a wide variety of projects.

Brush Diameter	Fill Diameter	Arbor Hole Diameter	Max RPM	Trim Length	Face Width	Item Number
Steel						
8	0.008	2	4,500	1-1/2	31/64	0002277300
8	0.012	2	4,500	1-1/2	31/64	0002277400
10	0.012	2	3,600	2	3/4	0002278300
12	0.012	2	3,000	1-7/8	13/16	0002279400



Small Diameter TY™ Encapsulated Wheel Brush–Standard Duty

The power and premium quality of an Osborn TY™ Encapsulated Wheel Brush sized down to fit hand-held air and electric tools such as pencil grinders. Ideal for confined areas, flash/rust removal, and aggressive deburring in tight spots.

Applications: Confined areas, deburring, flash and rust removal, cleaning and refining metal, plastic and rubber, heavy duty cleaning. Made in the USA.



Brush Diameter	Fill Diameter	Arbor Hole Diameter	Max RPM	Trim Length	Face Width	Item Number
Steel						
1-1/4	0.008	3/8	20,000	1/4	3/16	0001161700
1-3/8	0.006	1/4	20,000	3/8	3/16	0001161900
1-1/2	0.008	3/8	20,000	3/8	3/16	0001162300
1-1/2	0.014	3/8	20,000	3/8	3/16	0001162500
2	0.008	1/2	20,000	1/2	1/4	0001163200
2	0.012	1/2	15,000	1/2	1/4	0001163300
3	0.008	1/2	15,000	1	1/4	0001164700
3	0.008	5/8	15,000	15/16	1/4	0001165000
3	0.014	1/2	15,000	1	1/4	0001164800

TY™ Encapsulated Wheel Brush–Medium Face, Heavy Duty

Osborn's medium face, heavy duty TY™ Encapsulated Wheel Brush features maximum aggression for tougher applications, such as off-hand deburring and weld cleaning. Encapsulation minimizes long wire breakage for improved safety.



Brush Diameter	Fill Diameter	Arbor Hole Diameter	Max RPM	Trim Length	Face Width	Item Number
Steel						
1-1/2	0.014	3/8	20,000	3/8	3/16	0001169800
2	0.008	1/2	15,000	1/2	1/4	0001170200
2	0.014	1/2	15,000	1/2	1/4	0001170500
3	0.014	5/8	15,000	15/16	1/4	0001171800

TY™ Encapsulated Wheel Brush–Stringer Bead

Osborn's heavy duty TY™ Encapsulated Wheel Brush features a narrow face and crimped wire, ideal for standard stringer bead weld cleaning tasks. Premium quality wire firmly supported by elastomer provides uniform brush performance and lengthened life span.

Applications: Stringer bead weld cleaning. Made in the USA.



Brush Diameter	Fill Diameter	Arbor Hole Diameter	Max RPM	Trim Length	Face Width	Item Number
Steel						
6-7/8	0.014	2-1/16	9,000	1-5/8	3/16	0002188900

TY™ Encapsulated Wheel Brush–High Speed Knot Stringer, Heavy Duty

Tackle the toughest stringer bead weld cleaning projects with Osborn's high-speed heavy-duty knot stringer brush. Brushes feature TY™ encapsulation, which allows only the tip of the wire to be exposed for minimum wire breakage and maximum aggression. Designed with specialty hardware that allows brush to be operated safely at very high speeds on electric and air tools.

Applications: Stringer bead weld cleaning. Made in the USA.



Brush Diameter	Fill Diameter	Arbor Hole Diameter	Max RPM	Trim Length	Face Width	Item Number
4	0.020	5/8-11	15,000	1	3/16	0002636100

Other Fill Wheel Brushes

Small Diameter Nylon Wheel Brush

Osborn's Small Diameter Nylon Wheel Brush features durable synthetic filaments that are tough enough to remove burrs, scale, rust, carbon, corrosion, and plastic flash. Flexible, non-metallic fill material makes it an ideal choice for materials that would typically be damaged by wire brushes.

Applications: OD and ID cleaning, removes burrs, scale, rust, carbon, corrosion, plastic flash. Made in the USA.



Brush Diameter	Arbor Hole Diameter	Max RPM	Trim Length	Face Width	Item Number
Nylon					
1	1/4	20,000	13/64	1/8	0001113100
1-3/8	1/4	20,000	25/64	3/16	0001113400
1-1/2	3/8	20,000	3/8	3/16	0001113600
2	1/2	20,000	9/16	3/8	0001113900
2	1/2	20,000	9/16	1/4	0001114000
2	1/2	20,000	9/16	3/8	0001114100
3	5/8	15,000	15/16	3/8	0001114400
4	1-1/4	10,000	1	1/2	0001114300

Plater's Wire Wheel Brush

Flexible and soft-faced, Osborn's Plater's Wire Wheel Brushes produce an ultra-fine satin finish. Wheels feature durable staple set construction, individually anchoring each tuft of wire into the plastic hub for longer lifespan. Wire provides extra flexibility to service irregular surfaces and hard-to-reach areas. Choose from steel or brass wire to accommodate a wide variety of precious and non-ferrous metals.

Applications: Maintenance, metal surface cleaning



Brush Diameter	Fill Diameter	Arbor Hole Diameter	Max RPM	Trim Length	Face Width	Item Number
Steel						
6	0.005	1/2	3,600	2-1/2	15/16	0005405300
Brass						
6	0.006	1/2	3,600	2-1/2	15/16	0005405500

Small Diameter Tampico Wheel Brush

Well-constructed with flexible natural fibers, Osborn's Small Diameter Tampico Wheel Brushes are the ideal choice for removing burrs, scale, rust, carbon, corrosion and plastic flash. Smaller size and shortened trim length allow for controlled OD and ID cleaning performance in hard-to-reach areas.

Applications: OD and ID Cleaning, removes burrs, scale, rust, carbon, corrosion, plastic flash



Brush Diameter	Arbor Hole Diameter	Max RPM	Trim Length	Item Number
Tampico				
2-1/2	1/2	20,000	3/4	0001118200
3	1/2	20,000	1	0001118300
4	1-1/4	20,000	1	0001118400

Tampico Wheel Brush

Osborn's versatile Tampico Wheel Brush provides effective OD and ID cleaning, scrubbing, polishing, and dusting. Because the natural fibers are untreated, these are ideal for lighter operations that require brush flexibility. Brushes perform exceptionally wet or dry, and can be mounted singularly with flanges or in multiples for larger surfaces.



Brush Diameter	Arbor Hole Diameter	Max RPM	Trim Length	Item Number
Tampico				
6	2	6,000	1-5/8	0002001400
8	3-1/4	4,800	1-7/8	0002001600
10	3-1/4	4,250	2-7/8	0002001800
10	4-1/4	4,250	2-3/8	0002002000
12	4-1/4	3,600	3-3/8	0002002200
Tampico Heavy Duty				
8	4-1/4	4,800	1-3/8	0002007900

Crimped Polypropylene Wheel Brush

Premium quality Polypropylene filaments offer exceptional brush life and flexibility, making Osborn Crimped Polypropylene Wheel Brushes the ideal choice for lighter applications.



Brush Diameter	Arbor Hole Diameter	Max RPM	Trim Length	Item Number
Polypro				
6	2	6,000	1-5/8	0002011500
8	3-1/4	4,800	1-7/8	0002011600

Grit Wheel Brush with Shank

Constructed of standard Silicone Carbide, this brush is ideal for light-duty surface cleaning and deburring projects. All brushes are constructed with 1/4" shank.



Brush Diameter	Grit Size	Max RPM	Item Number
Silicon Carbide			
3	180	6,000	0009911800
4	80	6,000	0009911900
4	180	6,000	0009912000
3	80	6,000	0009911700



Safety First!

As a safety precaution, shank must be fully inserted into the chuck or collect and tightened securely.

Cup Brushes

Osborn cup brushes are designed for use in high speed air and electric tools, both portable and stationary machines. They are ideal for fast, heavy-duty cleaning of large surfaces, removing weld scale, rust, burrs, etc. The most popular configurations are also available with elastomer covered wire.

Cup Brush Selection Guide

Brush Material	Part Type	Aluminum	Brass	Copper	Iron	Plastic	Steel	Stainless Steel	Wood
Crimped Wire									
Steel		●	●	●	●	—	●	●	●
Stainless		◆	◆	◆	◆	—	◆	●	—
Nonferrous		◆	◆	◆	—	■	■	■	◆
Knotted Wire									
Steel		—	■	■	●	—	●	—	—
Stainless Steel		■	■	■	◆	—	◆	●	—
Nonferrous		●	●	●	—	—	■	■	—
TY™ Encapsulated									
Pliant Ploymer		—	—	—	●	—	●	●	—
Rigid Polymer		—	—	—	●	—	●	●	—

● Best Choice ◆ Very Good ■ Suitable — Not Recommended

Crimped Wire Cup Brushes

Designed for light and medium-duty applications on a variety of high speed air and electric tools. Offers smooth, responsive cutting action at all speeds for a variety of jobs. Cup brushes are measured by diameter of cup, not wire.

Crimped Wire Cup Brush

Osborn Cup Brushes provide quick, efficient cleaning of large metal surfaces. Manufactured with proprietary TufWire™ to offer high productivity and long life, and designed for use on portable power tools operating at high speeds.

Applications: Cleaning of large metal surfaces, removal of burrs, weld scale and rust, edge blending, surface prep



Brush Diameter	Fill Diameter	Arbor Hole Diameter	Max RPM	Trim Length	Item Number
Steel					
2-1/2	0.014	5/8-11	12,500	3/4	0009902400
3	0.014	5/8-11	12,500	29/32	0009902500
3	0.020	5/8-11	12,500	29/32	0009902600
3-1/2	0.006	5/8-11	7,500	1	0003204000
3-1/2	0.012	5/8-11	7,500	1	0003204800
3-1/2	0.020	5/8-11	7,500	1	0003205600
4	0.014	5/8-11	9,000	1-1/8	0009902700
4	0.020	5/8-11	9,000	1-1/8	0003213400
4	0.020	5/8-11	9,000	1-1/64	0009902800
5	0.012	5/8-11	8,000	1-1/2	0003214100
5	0.014	5/8-11	8,000	1-1/8	0009902900
5	0.020	5/8-11	8,000	1-1/2	0003213500
5	0.020	5/8-11	8,000	29/32	0009903000
6	0.020	5/8-11	7,000	1-1/2	0003213600
Stainless Steel					
3	0.014	5/8-11	12,500	29/32	0009903300
4	0.014	5/8-11	9,000	1-3/32	0009903400
5	0.014	5/8-11	8,000	1-1/8	0009903500
6	0.020	5/8-11	7,000	1-1/2	0003214400
Brass					
3-1/2	0.014	5/8-11	12,500	7/8	0003204700
4	0.020	5/8-11	9,000	1-1/8	0003204900

Crimped Wire Cup Brush with Shank

Osborn's premium quality Crimped Wire Cup Brushes feature an attached 1/4" shank for use on air tools and electric portable tools. Manufactured with proprietary TufWire™ wire strands for uniform light-duty cleaning and lengthened brush life.

Applications: Removal of dirt, rust, paint, scale, weld spatter



Brush Diameter	Fill Diameter	Max RPM	Trim Length	Item Number
Steel				
1-3/4	0.006	13,000	3/4	0001643800
1-3/4	0.012	20,000	3/4	0001644000
2	0.012	10,500	5/8	0003200400
2	0.014	10,500	5/8	0003200600
2-1/2	0.014	4,500	5/8	0003201400
2-1/2	0.010	4,500	5/8	0003201200
Stainless Steel				
1-3/4	0.006	25,000	3/4	0001643600
1-3/4	0.012	13,000	3/4	0001643500
2	0.008	10,500	5/8	0003207200
2	0.010	10,500	5/8	0003207400
2-1/2	0.008	4,500	5/8	0003207800
2-1/2	0.010	4,500	5/8	0003208000
Brass				
2-1/2	0.014	4,500	5/8	0003204600



Safety First!

As a safety precaution, shank must be fully inserted into the chuck or collect and tightened securely.

Problem

Smoother finish required



Solution

- Decrease wire diameter
- Increase surface speed
- Use an abrasive nylon Advanced Technology Brush (ATB™)

Finish too smooth and lustrous



- Increase wire diameter
- Decrease surface speed

Knot Wire Cup Brushes

Osborn knot wire cup brushes are rugged, efficient tools used for fast, heavy-duty cleaning of large metal surfaces. They are specially designed for use on portable tools and are filled with Osborn steel wire. Knot wire brushes are recommended for extremely rigorous jobs.

Knot Wire Cup Brush

Osborn Knot Wire Cup Brushes offer unmatched aggressiveness to tackle heavy-duty large surface jobs. Manufactured with proprietary best-in-class TufWire™, which allows for rigorous use and a longer lifespan. Designed to perform smoothly and efficiently on high-speed power tools.



Applications: Removal of weld scale, rust, old paint and corrosion, cleaning and surface prep of metals

Brush Diameter	Fill Diameter	Arbor Hole Diameter	Max RPM	Trim Length	Item Number
Steel					
2-1/2	0.014	5/8-11	12,500	5/8	0009903600
2-1/2	0.020	5/8-11	12,500	5/8	0009903700
3	0.014	5/8-11	7,500	3/4	0009903800
3	0.020	5/8-11	7,500	3/4	0009903900
3-1/2	0.020	5/8-11	7,500	1-3/8	0003300500
3-1/2	0.020	5/8-11	7,500	1-3/8	0003312600
4	0.014	5/8-11	6,000	1-1/4	0003313700
4	0.014	5/8-11	6,000	1-1/8	0009904000
4	0.020	5/8-11	6,000	1	0003313300
4	0.020	5/8-11	6,000	1-1/8	0009904100
4	0.026	5/8-11	6,000	1-1/4	0003313800
5-3/4	0.026	5/8-11	6,000	1-5/8	0003313500
6	0.014	5/8-11	6,000	1-3/4	0003301100
6	0.014	5/8	6,000	1-3/4	0003302400
6	0.014	5/8-11	6,000	1-3/4	0003302600
6	0.020	5/8-11	6,000	1-3/4	0003301500
6	0.020	5/8-11	6,000	1-3/4	0003303000
6	0.020	5/8-11	6,000	1-3/4	0003312700
6	0.020	5/8-11	6,600	1-1/4	0003315000
6	0.020	5/8-11	6,000	1-1/2	0009904300
6	0.026	5/8-11	6,000	1-3/4	0003302200
6	0.035	5/8-11	6,000	1-3/4	0003302100
6	0.035	5/8-11	6,000	1-3/4	0003303400
6	0.035	5/8-11	6,000	1-3/4	0003312800
Stainless Steel					
2-1/2	0.014	5/8-11	12,500	5/8	0009904400
3	0.014	5/8-11	7,500	3/4	0009904600
3-1/2	0.014	5/8-11	7,500	1-3/8	0003304500
4	0.020	5/8-11	6,000	1-1/4	0003313900
4	0.020	5/8-11	6,000	1-1/8	0009904700
6	0.020	5/8-11	6,000	1-3/4	0003304900
6	0.020	5/8-11	6,000	1-3/4	0003313400
Brass					
3-1/2	0.014	5/8-11	7,500	7/8	0003300600

Knot Wire Flared Cup Brush

Experience the premium quality of Osborn Knot Wire Cup Brushes in a wider diameter. Flared wire covers more surface area to make quick work of heavy-duty cleaning and surface preparation tasks. Proprietary TufWire™ provides increased rigidity and aggressiveness, consistent performance and long brush life to save you time and money.

Applications: Fast heavy-duty cleaning of large metal surfaces, removal of weld scale, rust, old paint and corrosion, pre-paint surface prep. Made in the USA.



Brush Diameter	Fill Diameter	Arbor Hole Diameter	Max RPM	Trim Length	Item Number
Steel					
6	0.020	5/8-11	7,000	1-5/8	0002626100

Knot Wire Cup Brush–Reduced Flare, Heavy Duty

Densely packed knotted wire makes Osborn's Knot Wire Cup Brush the ideal option for tough tasks such as deburring, paint removal, weld scale removal, and the cleaning and prep of large surface areas. Brushes are constructed with heavy duty TufWire™ with a reduced flare, providing unmatched rigidity and aggressiveness. Can be used on a variety of stationary and portable tools.

Applications: Deburring, cleaning or prep of large surface areas, paint removal, removal of weld scale. Made in the USA.



Brush Diameter	Fill Diameter	Arbor Hole Diameter	Max RPM	Trim Length	Item Number
Steel					
6	0.020	5/8-11	6,000	1-3/4	0003307200

Knot Wire Cup Brush w/ Bridle–Heavy Duty

Designed for toughness and longevity, Osborn's heavy duty Knot Wire Brush with Bridle provides rugged and efficient use on a variety of maintenance or cleaning applications. Featuring proprietary TufWire™ and a bridle to reduce the flare of wires, these brushes provide a more aggressive brush face for rigorous tasks. Bridles can be removed after partial wear for longer brush life and continued uniform performance. Made in the USA.



Brush Diameter	Fill Diameter	Arbor Hole Diameter	Max RPM	Trim Length	Item Number
Steel					
4	0.014	5/8-11	7,000	1-3/4	0003309100
5	0.023	1-1/16	4,500	1-7/8	0003397200

Knot Wire Cup Brush–Staggered Row

Constructed of proprietary TufWire™ with a staggered knot design, Osborn's staggered row Knot Wire Cup Brush offers extra fast cutting and cleaning action over wide areas. Twisted wire strands near the base of the brush provide rigidity and aggressiveness, while splayed ends cover wide areas quickly and efficiently.



Applications: Cleaning of flat surfaces, angles and corners, surface prep, removal of oils, grease rust, paint and varnish. Made in the USA.

Brush Diameter	Fill Diameter	Arbor Hole Diameter	Max RPM	Trim Length	Item Number
Steel					
5-3/4	0.020	5/8-11	6,000	1-3/4	0003319800



Safety First!

- Always wear eye protection
- Observe maximum safe free speed (MSFS)
- Ensure machine guards are in place
- Wear all appropriate personal protection equipment

TY™ Encapsulated Cup Brushes

With specially formulated polymer that supports each wire working point to provide maximum work with minimum pressure. They are easily mounted on both portable air and electric tools and finishing machines.

TY™ Black Max Encapsulated Cup Brush– Extra Heavy Duty

The toughest projects call for even tougher tools. Osborn's TY™ Black Max Encapsulated Cup Brush features TufWire™ steel wire strands encapsulated in a heat-resistant polymer for extra heavy duty usage. With encapsulation, only the tips of the wire are exposed, increasing rigidity for maximum aggression.



Brush Diameter	Fill Diameter	Arbor Hole Diameter	Max RPM	Trim Length	Item Number
Steel					
4	0.020	5/8-11	9,000	1-1/4	0003200200

TY™ Encapsulated Cup Brush with Shank– Standard Duty

Osborn's TY™ Encapsulated Cup Brush with 1/4" Shank is constructed with proprietary TufWire™ with a specially formulated polymer that supports wire strands. The result is maximum performance with minimum pressure. Shank allows brush to be easily mounted to portable tools.



Note: As a safety precaution, the shank must be fully inserted into the chuck or collet and tightened securely.



Safety First!

As a safety precaution, shank must be fully inserted into the chuck or collect and tightened securely.

Brush Diameter	Fill Diameter	Max RPM	Trim Length	Item Number
Steel				
2-1/2	0.014	5,000	5/8	0003261000
Stainless Steel				
2-1/2	0.010	4,500	5/8	0003266000

TY™ Encapsulated Cup Brush–Standard Duty

Osborn's TY™ Encapsulated Cup Brush is constructed with proprietary TufWire™ with a specially formulated polymer that supports wire strands, resulting in maximum performance with minimum pressure.



Brush Diameter	Fill Diameter	Arbor Hole Diameter	Max RPM	Trim Length	Item Number
Steel					
3-1/2	0.012	5/8-11	7,500	7/8	0003262900
3-1/2	0.020	5/8-11	7,500	1	0003263100
5-3/4	0.020	5/8-11	6,000	1-1/2	0003264800

High Speed Small Grinder Cup Brushes

Made for use on portable power tools operating at high speeds, or where uniform cleaning is desired. Designed for high productivity and long life. Knot style offers aggressive action. Available in crimped, knotted and heavy-duty knotted styles. They are designed for 4-1/2" and 5" grinders.

High Speed Small Grinder Crimped Wire Cup Brush

Designed for light- and medium-duty cleaning tasks, Osborn High Speed Small Grinder Crimped Wire Cup Brushes provides uniform performance at high speeds. Brushes are made for use on portable 4-1/2" and 5" grinders and are ideal for cleaning and preparing flat surfaces and edges.

Applications: Cleans and prepares flat surfaces and edges, light and medium duty cleaning. Made in the USA.



Brush Diameter	Fill Diameter	Arbor Hole Diameter	Max RPM	Trim Length	Item Number
Steel					
2-3/4	0.014	M14-2	14,000	1	0003202600
2-3/4	0.014	M10-1.25	14,000	1	0003202700
2-3/4	0.014	1/2-13	14,000	1	0003202900
2-3/4	0.014	5/8-11	14,000	1	0003203000
2-3/4	0.014	3/8-24	14,000	1	0003203200
3-1/2	0.014	5/8-11	12,500	7/8	0003203400
Stainless Steel					
2-3/4	0.014	5/8-11	14,000	1	0003208600

High Speed Small Grinder Knot Wire Cup Brush-Heavy Duty

Designed for extra heavy-duty tasks, Osborn heavy-duty High Speed Small Grinder Knot Wire Cup Brushes are specially treated to withstand rigorous use. Premium quality knot style TufWire™ prevents premature failure and provides aggressive cleaning and pipe bevel buffing. Brushes are made for use on portable 4-1/2" and 5" grinders.

Applications: General cleaning, cleaning of curved or flat surfaces and corners, pipe bevel buffing



Brush Diameter	Fill Diameter	Arbor Hole Diameter	Max RPM	Trim Length	Item Number
Steel					
3-1/2	0.020	5/8-11	12,500	7/8	0003300000
Stainless Steel					
3-1/2	0.020	5/8-11	12,500	7/8	0003300100

High Speed Small Grinder Knot Wire Cup Brush

Designed for heavy-duty tasks, Osborn High Speed Small Grinder Knot Wire Cup Brush feature proprietary TufWire™ for aggressive, yet uniform brushing action. This versatile brush makes quick work of scale removal, deburring, and weld cleaning, and is made for use on portable 4-1/2" and 5" grinders.



Applications: Removes scale, deburrs, cleans welds and flat surfaces. Made in the USA.

Brush Diameter	Fill Diameter	Arbor Hole Diameter	Max RPM	Trim Length	Item Number
Steel					
2-3/4	0.014	M14-2.00	14,000	7/8	0003335500
2-3/4	0.014	M10-1.25	14,000	7/8	0003335600
2-3/4	0.014	M10-1.25	14,000	7/8	0003335700
2-3/4	0.014	1/2-13	14,000	7/8	0003335800
2-3/4	0.014	5/8-11	14,000	7/8	0003335900
2-3/4	0.014	3/8-24	14,000	7/8	0003336000
2-3/4	0.020	M10-1.25	14,000	7/8	0003345600
2-3/4	0.020	1/2-13	14,000	7/8	0003345800
2-3/4	0.020	5/8-11	14,000	7/8	0003345900
2-3/4	0.020	3/8-24	14,000	7/8	0003346000
Stainless Steel					
2-3/4	0.014	M10-1.25	14,000	7/8	0003336400
2-3/4	0.014	5/8-11	14,000	7/8	0003336700
2-3/4	0.020	1/2-13	14,000	7/8	0003346600
2-3/4	0.020	5/8-11	14,000	7/8	0003346700
2-3/4	0.020	3/8-24	14,000	7/8	0003346800

Bridled Cup Brushes

Knot Wire Bridled Cup Brush

Osborn's Knot Wire Bridled Cup Brush features a unique knotted design for strength and longevity. Bridle reduces the flare of the wires for increased aggressiveness, and can be removed after partial wear to extend the useful life of the brush.



Brush Diameter	Fill Diameter	Arbor Hole Diameter	Max RPM	Trim Length	Item Number
Steel					
3	0.020	5/8-11	11,000	3/4	0009904900
3	0.020	5/8-11	12,000	5/8	0009913100
4	0.014	5/8-11	8,500	1-1/8	0009905000
4	0.020	5/8-11	8,500	1-1/8	0009905100
5	0.020	5/8-11	6,500	7/8	0009905300
Stainless Steel					
3	0.020	5/8-11	12,000	5/8	0009913200

Other Fill Cup Brushes

Circular Polypropylene Scrub Brush

Featuring premium-quality materials and construction, Osborn's Circular Polypropylene Scrub Brushes are designed for long-term use. Brushes are densely filled with Osborn's long-wearing polypropylene material, and each tuft is firmly anchored into a marine-type block. Designed for use on off-hand equipment as well as automatic machinery.

Applications: Circuit board cleaning, glass & mirror polishing



Brush Diameter	Arbor Hole Diameter	Trim Length	Item Number
Polypro			
6	1/2	1-1/4	0005407700

Grit Cup Brush with Shank

Designed for standard duty with choice of 80 or 180 grit, Osborn's grit cup brushes are ideal for a wide variety of cleaning and finishing jobs. Shank mounted for convenient use on hand-held power tools. All brushes are constructed with a 1/4" shank.



Brush Diameter	Grit Size	Max RPM	Item Number
Silicon Carbide			
2	80	5,000	0009912100
2	180	5,000	0009912200
3	80	5,000	0009912300
3	180	5,000	0009912400



Safety First!

As a safety precaution, shank must be fully inserted into the chuck or collect and tightened securely.

End Brushes

Especially suited for use on portable air and electronic tools, CNC and robotic equipment, the end brush is designed for work where space limitation is a factor. In most applications, higher speeds (up to 25,000 RPM) are required for effective brushing action. Osborn end brush fill materials include carbon and stainless steels, brass, natural fiber, ATB™ abrasive nylon, and TY™ elastomer encapsulated wire.

End Brush Selection Guide

Brush Material	Part Type	Aluminum	Brass	Copper	Iron	Plastic	Steel	Stainless Steel
Crimped Wire								
Steel		—	◆	◆	●	—	●	—
Stainless		◆	◆	◆	◆	—	◆	●
Nonferrous		◆	●	●	—	■	■	■
Knotted Wire								
Steel		—	—	—	●	—	●	—
Stainless Steel		—	—	—	◆	—	◆	●
TY™ Encapsulated Wire								
Pliant Ploymer		—	—	—	●	—	●	●
Rigid Polymer		—	—	—	●	—	●	●
Natural Fibers								
Treated Tampico		◆	◆	◆	◆	●	●	●

● Best Choice ◆ Very Good ■ Suitable — Not Recommended

Crimped Wire End Brushes

Crimped Wire End Brush

Osborn's Crimped Wire End Brush features high-quality wire construction and a 1/4" shank for convenient mounting on hand-held power tools and CNC equipment. Engineered to provide uniform brushing action when operated at high speeds. Small diameter and brush flexibility make them ideal for recesses and other difficult-to-reach areas.



Applications: Rubber and plastic mold cleaning, cleaning pipe I.D., removing rust, weld scale and spatter, cleaning castings, burr removal, rubber flash removal, carbon removal, spot facing, cleaning and finishing recessed areas

Brush Diameter	Fill Diameter	Max RPM	Trim Length	Item Number
Steel				
3/8	0.006	20,000	1	0003009100
3/8	0.010	20,000	1	0003009200
1/2	0.006	25,000	1	0003005100
1/2	0.010	25,000	1	0003005300
1/2	0.020	25,000	1	0003005500
3/4	0.006	22,000	1	0003005700
3/4	0.010	22,000	1	0003005900
3/4	0.014	20,000	1	0009910400
3/4	0.020	22,000	1	0003006100
1	0.006	22,000	1	0003006300
1	0.010	22,000	1	0003006500
1	0.014	20,000	1	0009910500
1	0.020	22,000	1	0003006700
1	0.020	22,000	1	0003039700
1	0.020	20,000	1	0009910600
Stainless Steel				
1/2	0.005	25,000	1	0003007100
1/2	0.010	25,000	1	0003001900
1/2	0.014	25,000	1	0003002000
3/4	0.006	22,000	1	0003002100
3/4	0.010	22,000	1	0003007900
3/4	0.010	20,000	1	0009910700
3/4	0.014	22,000	1	0003002200
1	0.005	22,000	1	0003008300
1	0.010	22,000	1	0003008500
1	0.010	20,000	1	0009910800
1	0.014	22,000	1	0003002500
Brass				
1	0.006	22,000	1	0003007400



Safety First!

As a safety precaution, shank must be fully inserted into the chuck or collet and tightened securely.

Crimped Wire End Brush–Scuf-Gard

This Osborn crimped wire end brush is specially manufactured with a rugged, durable layer of elastomer on the cup to prevent accidental scratching or marring of the work surface during operation. Attached 1/4" shank conveniently mounts on hand-held power tools and CNC equipment, and is engineered to provide uniform brushing action when operated at high speeds.



Brush Diameter	Fill Diameter	Max RPM	Trim Length	Item Number
Steel				
1/2	0.006	25,000	1	0003011600
1/2	0.010	25,000	1	0003011800
3/4	0.006	22,000	1	0003012100
1	0.010	22,000	1	0003012800
Stainless Steel				
1/2	0.005	25,000	1	0003013100
1/2	0.010	25,000	1	0003013300
3/4	0.010	22,000	1	0003013800
1	0.005	20,000	1	0003014100
1	0.010	22,000	1	0003014300

Circular Crimped Wire End Brush

Osborn's Crimped Wire End Brush is constructed of premium quality wire, flared to cover wide areas and irregular surfaces. Available in four brush diameters with steel or stainless steel wire to tackle a variety of tasks quickly and efficiently, including weld cleaning, rust and paint removal, polishing molds, tools and dies, and deburring. Includes 1/4" shank for quick, convenient mounting on hand-held power tools.



Applications: Cleaning welds, molds, or metal surfaces, removing rust and paint, polishing molds, tooling and dies, deburring

Brush Diameter	Fill Diameter	Max RPM	Trim Length	Item Number
Steel				
1-1/4	0.006	15,000	1	0003025100
1-1/2	0.008	15,000	1	0003023400
1-1/2	0.020	15,000	1	0003025500
2	0.010	15,000	1	0003027600
2	0.014	15,000	1	0003023200
3	0.006	15,000	1	0003027900
3	0.008	15,000	1	0003023100
3	0.014	15,000	1	0003022800
3	0.020	15,000	1	0003025800
Stainless Steel				
1-1/4	0.005	15,000	1	0003025000
1-1/2	0.005	15,000	1	0003023300
2	0.010	15,000	1	0003027700
3	0.005	15,000	1	0003027800
3	0.010	15,000	1	0003028000
3	0.014	15,000	1	0003022900



Safety First!

As a safety precaution, shank must be fully inserted into the chuck or collet and tightened securely.

Knot Wire End Brushes

Rugged brushing tools designed with the finest wire to offer efficient usage for a wide variety of tough cleaning and maintenance applications; can be used on CNC equipment.

Knot Wire End Brush

Featuring proprietary TufWire™ wire strands twisted for added strength, Osborn Knot Wire End Brushes offers efficient, rugged brushing action to tackle a wide variety of tough cleaning and maintenance applications. Ideal for hard-to-reach areas and inner diameters, and can be operated at high speed on CNC equipment.

Applications: Spot cleaning or facing, removal of slag, rust or scale, cleaning pipe ID, deburring or flash removal, cleaning of dies, molds and tooling, pipeline cleaning



Brush Diameter	Fill Diameter	Max RPM	Trim Length	Item Number
Steel				
1/2	0.006	22,000	1-1/8	0003000200
1/2	0.010	22,000	1-1/8	0003000400
1/2	0.010	22,000	7/8	0003010300
1/2	0.014	22,000	1-1/8	0003000500
1/2	0.014	22,000	7/8	0003010400
3/4	0.006	22,000	1-1/8	0003000800
3/4	0.010	22,000	1-1/8	0003001000
3/4	0.014	22,000	1-1/8	0003001100
3/4	0.014	22,000	7/8	0003010700
3/4	0.014	20,000	1	0009909800
3/4	0.020	22,000	1-1/8	0003001200
3/4	0.020	22,000	7/8	0003010900
3/4	0.020	20,000	1	0009909900
1	0.006	20,000	1-1/8	0003001400
1	0.010	20,000	1-1/8	0003001600
1	0.010	22,000	1-1/8	0003009500
1	0.010	25,000	1	0003050400
1	0.012	20,000	1	0009910000
1	0.014	22,000	7/8	0003011200
1	0.014	20,000	1-1/8	0003012300
1	0.014	25,000	1	0003050200
1	0.014	20,000	1	0009910100
1	0.020	20,000	1	0003001800
1	0.020	22,000	7/8	0003011300
1	0.020	20,000	1-1/8	0003012200
1	0.020	25,000	1	0003050000
1	0.020	20,000	1	0009910200
	0.014	22,000	1	0003039500
Stainless Steel				
1/2	0.006	22,000	1-1/8	0003042600
1/2	0.010	22,000	1-1/8	0003042800
1/2	0.014	22,000	1-1/8	0003042900
3/4	0.006	22,000	1-1/8	0003043200
3/4	0.010	22,000	1-1/8	0003043400
3/4	0.014	22,000	1-1/8	0003043500
1	0.006	20,000	1-1/8	0003043800
1	0.010	20,000	1-1/8	0003044000
1	0.010	25,000	1	0003050500
1	0.014	20,000	1	0003001700
1	0.014	20,000	1	0003044100
1	0.014	25,000	1	0003050300
1	0.014	20,000	1	0009910300
Brass				
1	0.014	20,000	1	0003007500



Safety First!

As a safety precaution, shank must be fully inserted into the chuck or collet and tightened securely.

Knot Wire End Brush - Scuf-Gard

This Osborn knot wire end brush is specially manufactured with a rugged, durable layer of elastomer on the cup to prevent accidental scratching or marring of the work surface during operation. Constructed with TufWire™ for added strength and unmatched brush life. Attached 1/4" shank conveniently mounts on hand-held power tools and CNC equipment, and is engineered to provide aggressive, uniform brushing action when operated at high speeds.



Brush Diameter	Fill Diameter	Max RPM	Trim Length	Item Number
Stainless Steel				
1/2	0.006	22,000	1-1/8	0003002600
1/2	0.010	22,000	1-1/8	0003002800
1/2	0.014	22,000	1-1/8	0003002900
3/4	0.006	22,000	1-1/8	0003003200
3/4	0.010	20,000	1-1/8	0003003400
3/4	0.014	22,000	1-1/8	0003003500
1	0.006	20,000	1-1/8	0003003800
1	0.010	20,000	1-1/8	0003004000
1	0.014	20,000	1	0003004100

TY™ Encapsulated End Brushes

TY™ polymer supports each wire working point to provide maximum work with minimum pressure. The unique shapes and characteristics of TY™ encapsulated end brushes make them ideal for unusual applications.

TY™ Encapsulated End Brush–Standard Duty

Osborn's TY™ Encapsulated End Brush is constructed with proprietary TufWire™ encased in a specially formulated elastomer that supports wire for maximum work with minimum pressure. Elastomer wears back gradually, extending brush life and maintaining optimum performance.

Applications: Burr removal, rubber flash, weld scale, rust, paint



Brush Diameter	Fill Diameter	Max RPM	Trim Length	Item Number
Steel				
3/8	0.006	20,000	1	0003055800
3/8	0.010	20,000	1	0003055900
1/2	0.006	18,000	1	0003060000
1/2	0.010	18,000	1	0003060200
1/2	0.020	18,000	1	0003060400
3/4	0.006	15,000	1	0003060500
3/4	0.010	15,000	1	0003060700
3/4	0.020	15,000	1	0003060900
1	0.010	13,000	1	0003061200
1	0.020	13,000	1	0003061400
Stainless Steel				
1/2	0.005	18,000	1	0003061500
3/4	0.010	15,000	1	0003061900
1	0.010	13,000	1	0003062200



Safety First!

As a safety precaution, shank must be fully inserted into the chuck or collet and tightened securely.

TY™ Encapsulated Flared End Brush–Heavy Duty

Constructed of pre-flared and bonded TufWire™ and encased in a rigid elastomer, Osborn's TY™ Encapsulated Flared End Brush is designed for heavy-duty applications. The small brush diameter makes it an ideal choice for confined, tough-to-reach areas. Elastomer gradually wears back, exposing a short wire trim for maximum cut.

Applications: Weld prep, weld cleaning, confined area general cleaning



Brush Diameter	Fill Diameter	Max RPM	Trim Length	Item Number
Steel				
1-3/4	0.006	25,000	1-1/8	0003065000
1-3/4	0.010	25,000	1-1/8	0003065100
1-3/4	0.020	25,000	1-1/8	0003065300
2	0.010	20,000	1-1/4	0003065900
2	0.020	20,000	1-1/4	0003066100
2-3/4	0.006	15,000	1-1/2	0003066600
2-3/4	0.010	15,000	1-1/2	0003066700
2-3/4	0.020	15,000	1-1/2	0003066900
Stainless Steel				
1-3/4	0.010	25,000	1-1/8	0003065500
2	0.010	20,000	1-1/4	0003066300
2-3/4	0.010	15,000	1-1/2	0003067100

Specialty End Brushes

Pilot Bonding End Brush

Banded with a specially made ring to expose a short 3/8" trim length for rigidity. Available with crimped steel or stainless steel TufWire™ with center-mounted pilot. Primarily used for aircraft assembly and in the aerospace industry.



Applications: Pot facing, rivet hole cleaning and deburring, cleaning metal surfaces

Brush Diameter	Fill Diameter	Max RPM	Trim Length	Item Number
Steel				
1/2	0.004	25,000	3/8	0003014500
1/2	0.004	25,000	3/8	0003014800
1/2	0.004	25,000	3/8	0003015100
1/2	0.004	25,000	3/8	0003015400
1/2	0.004	25,000	3/8	0003015700
Stainless Steel				
1/2	0.004	25,000	3/8	0003019000
1/2	0.004	25,000	3/8	0003019300
1/2	0.004	25,000	3/8	0003019600
1/2	0.004	25,000	3/8	0003019900



Safety First!

As a safety precaution, shank must be fully inserted into the chuck or collect and tightened securely.

Bridled End Brushes

Bridle helps reduce flare and increases the aggressiveness of the brush. Bridles are removable to adjust for wear.

Brass Wire End Brush–Bridled

Constructed of premium-quality brass wire with removable bridle, Osborn's Brass Wire End Brush is the ideal choice for mold cleaning. Bridle reduces flare to increase brush aggressiveness, and can be removed to adjust for wear. Includes 1/4" shank for easy attachment to hand-held power tools.

Applications: Mold cleaning



Brush Diameter	Fill Diameter	Max RPM	Trim Length	Item Number
Brass				
1/2	0.005	10,000	1	0003024100
1	0.005	7,500	1	0003024700

Non-Metallic End Brush–Bridled

Designed with durable polypropylene fill with removable bridle, Osborn's versatile Non-Metallic End Brush can be used for a variety of general cleaning and plastic flash removal applications. Bridle reduces flare to increase brush rigidity, and can be removed to adjust for wear. Includes 1/4" shank for easy attachment to hand-held power tools.

Applications: General cleaning and plastic flash removal



Brush Diameter	Fill Diameter	Max RPM	Trim Length	Item Number
Polypro				
1	0.010	12,000	1-5/8	0003027500



Safety First!

As a safety precaution, shank must be fully inserted into the chuck or collect and tightened securely.

Internal Brushes

Internal brushes, also known as “side action” brushes, are designed for use on portable tools and drill presses. They provide hard-working brush action for fast, thorough cleaning and finishing in such hard-to-reach places such as small diameter holes, internally threaded surfaces, and many otherwise inaccessible areas. Fill materials include steel, stainless steel, brass and nylon.

Internal Brush Selection Guide

Brush Material	Part Type	Aluminum	Brass	Copper	Iron	Plastic	Steel	Stainless Steel
Crimped Wire								
Steel		—	◆	◆	●	—	●	—
Stainless		◆	◆	◆	◆	—	◆	●
Nonferrous		◆	●	●	—	■	■	■
Knotted Wire								
Steel		—	—	—	●	—	●	—
Stainless Steel		—	—	—	◆	—	◆	●
TY™ Encapsulated Wire								
Pliant Ploymer		—	—	—	●	—	●	●
Rigid Polymer		—	—	—	●	—	●	●
Natural Fibers								
Treated Tampico		◆	◆	◆	◆	●	●	●

● Best Choice ◆ Very Good ■ Suitable — Not Recommended

Internal Brushes

Internal brushes are available in several filament styles, allowing you to choose the right brush for your application. These brushes are ideal for reaching into holes and crevices where other brushes cannot.

HeliTuf™ Crimped Wire Internal Brush

Featuring a unique helix design that is densely packed with steel or stainless steel, Osborn's HeliTuf™ Crimped Wire Internal Brush provides rugged brushing action to tackle recessed cleaning tasks quickly and efficiently. Ideal for cleaning the internal diameter of a hole, cleaning threads and brushing edges of keyways, and can be used by hand or with power tools.

Applications: Cleaning the entire inside circumference of a hole, cleaning out threaded areas, brushing edges of keyways and other recesses



Brush Diameter	Brush Area Length	Stem Diameter	Fill Diameter	Overall Length	Item Number
Steel					
1/4	1	1/8	0.005	3-1/2	0003601200
3/8	1	1/8	0.005	3-1/2	0003602200
3/8	1	1/8	0.008	3-1/2	0003602300
7/16	1	1/8	0.005	3-1/2	0003602700
1/2	1	1/8	0.005	3-1/2	0003603200
1/2	1	1/8	0.008	3-1/2	0003603300
9/16	1	1/8	0.005	3-1/2	0003603700
5/8	1	1/8	0.005	3-1/2	0003604200
5/8	1	1/8	0.008	3-1/2	0003604300
11/16	1	1/8	0.005	3-1/2	0003604700
3/4	1	1/8	0.005	3-1/2	0003605200
3/4	1	1/8	0.008	3-1/2	0003605300
13/16	1	1/8	0.005	3-1/2	0003605700
7/8	1	1/8	0.005	3-1/2	0003606200
7/8	1	1/8	0.008	3-1/2	0003606300
15/16	1	1/8	0.005	3-1/2	0003606700
1	1	1/8	0.005	3-1/2	0003607200
1	1	1/8	0.008	3-1/2	0003607300
1-1/8	1	1/8	0.005	3-1/2	0003608200
1-1/4	1	1/8	0.008	3-1/2	0003609300
Stainless Steel					
1/4	1	1/8	0.005	3-1/2	0003613900
3/8	1	1/8	0.005	3-1/2	0003614700
3/8	1	1/8	0.008	3-1/2	0003614800
7/16	1	1/8	0.005	3-1/2	0003615100
1/2	1	1/8	0.005	3-1/2	0003615500
1/2	1	1/8	0.008	3-1/2	0003615600
5/8	1	1/8	0.005	3-1/2	0003616300
5/8	1	1/8	0.008	3-1/2	0003616400
11/16	1	1/8	0.005	3-1/2	0003616700
3/4	1	1/8	0.008	3-1/2	0003617200
7/8	1	1/8	0.005	3-1/2	0003617900
1	1	1/8	0.005	3-1/2	0003618700
1	1	1/8	0.008	3-1/2	0003618800
1-1/8	1	1/8	0.005	3-1/2	0003619500
1-1/4	1	1/8	0.008	3-1/2	0003620400

Did you know? Featuring two sizes of extension holders and 12 HeliTuf™ brushes, ranging from 3/8" to 1-1/8", the HeliTuf™ Brush Kit (0003600000) has the right sized tool for any application.



Use with HeliTuf™ extension holder 0007500300 features a 3/16" externally threaded stem, while extension holder 0007500400 features a 1/4" internally threaded stem. Use both extension holders together to form an 8" long brush.

Situff™ Crimped Wire Internal Brush

Osborn Situff™ Crimped Wire Internal Brushes features densely packed tufts of proprietary TufWire™ steel wire strands for optimal side-action brushing and brush longevity. Conveniently adapts to drill presses, lathes, bench grinders and portable tools to tackle a wide variety of recess cleaning applications, such as inside diameters, threads and keyways.

Applications: Cleaning the entire inside circumference of a hole, cleaning out threaded areas, brushing edges of keyways and other recesses



Brush Diameter	Brush Area Length	Stem Diameter	Fill Diameter	Overall Length	Item Number
Steel					
1/4	9/16	3/32	0.003	2-1/8	0003502100
1/4	9/16	3/32	0.005	2-1/8	0003502300
9/32	9/16	3/32	0.005	2-1/8	0003502700
5/16	9/16	3/32	0.003	2-1/8	0003503100
5/16	9/16	3/32	0.005	2-1/8	0003503200
3/8	9/16	3/32	0.003	2-1/8	0003504100
3/8	9/16	3/32	0.005	2-1/8	0003504200
3/8	9/16	3/32	0.008	2-1/8	0003504300
7/16	9/16	3/32	0.003	2-1/8	0003505100
7/16	9/16	3/32	0.005	2-1/8	0003505200
1/2	9/16	3/32	0.003	2-1/8	0003506100
1/2	9/16	3/32	0.005	2-1/8	0003506200
1/2	5/8	1/8	0.005	2-1/4	0003507700
1/2	9/16	3/32	0.008	2-1/8	0003506300
1/2	5/8	1/8	0.008	2-1/4	0003507800
9/16	5/8	3/32	0.003	2-1/4	0003508100
9/16	5/8	1/8	0.005	2-1/4	0003508200
5/8	5/8	1/8	0.003	2-1/4	0003508600
5/8	5/8	1/8	0.005	2-1/4	0003508700
5/8	5/8	1/8	0.008	2-1/4	0003508800
3/4	5/8	1/8	0.003	2-1/4	0003509600
3/4	5/8	1/8	0.005	2-1/4	0003509700
3/4	5/8	1/8	0.008	2-1/4	0003509800
7/8	5/8	1/8	0.005	2-1/4	0003510700
1	5/8	1/8	0.005	2-1/4	0003511700
1	5/8	1/8	0.008	2-1/4	0003511800
1-1/8	5/8	1/8	0.005	2-1/4	0003512700
1-1/4	5/8	1/8	0.005	2-1/4	0003513700
1-1/4	5/8	1/8	0.008	2-1/4	0003513800
Stainless Steel					
5/32	7/16	1/16	0.003	2-1/4	0003517600
1/4	9/16	3/32	0.005	2-1/8	0003518100
3/8	9/16	3/32	0.005	2-1/8	0003518900
1/2	9/16	3/32	0.005	2-1/8	0003519700
5/8	5/8	1/8	0.005	2-1/4	0003520500
3/4	5/8	1/8	0.005	2-1/4	0003521300
7/8	5/8	1/8	0.005	2-1/4	0003522100
1	5/8	1/8	0.005	2-1/4	0003522900
1-1/4	5/8	1/8	0.005	2-1/4	0003524500
Brass					
1/4	9/16	3/32	0.005	2-1/4	0003528100
7/16	9/16	3/32	0.005	2-1/8	0003529000
1/2	9/16	3/32	0.005	2-1/8	0003529300
7/8	5/8	1/8	0.005	2-1/4	0003531100



Use with Situff™ holder 0007500500 for brushes with 3/32" stems and Situff holder 0007500600 for brushes with 1/8" stems

Situff™ Nylon Internal Brush

Applications: Cleaning interior surfaces, removing dirt

Brush Diameter	Brush Area Length	Stem Diameter	Fill Diameter	Overall Length	Item Number
Nylon					
1/2	9/16	3/32	0.010	2-1/8	0003535800



Straight Wire Tube Brush–Double Stem, Double Spiral



Constructed of premium steel filament with up to 3-1/2" of brush area length, Osborn Straight Wire Tube Brushes quickly clean threads, drilled holes, and tubes where space is limited. Can be used as a hand tool, mounted in a drill press, or on a portable power tool.

Brush Diameter	Brush Area Length	Stem Diameter	Fill Diameter	Overall Length	Item Number
Steel					
1/4	2	0.163	0.006	6	0005105000
3/8	2	0.163	0.006	6	0005105100
1/2	2	0.163	0.006	6	0005105200
5/8	3-1/2	0.163	0.006	5-1/2	0005105300
3/4	3-1/2	0.163	0.006	5-1/2	0005105400
7/8	3-1/2	0.163	0.006	5-1/2	0005105600

Flue Brush–Straight Wire, Double Spiral



Premium quality steel filament makes quick work of internally cleaning pipes and flues. Available in a variety of diameters for various sized projects. All standard flues are referred to by their outside diameter, which is usually 1/4" larger than its inside diameter (For example: the diameter of a 3" Flue Brush is approximately 2-3/4", or the inside diameter of a standard 3" flue.) Brushes are designed for manual cleaning or for use with power tools.

Applications: Manual or power cleaning of pipes and flues

Brush Diameter	Brush Area Length	Fill Diameter	Item Number
Steel			
1/2	4-1/2	0.010	0005106000
5/8	4-1/2	0.010	0005106100
3/4	4-1/2	0.010	0005106200
7/8	4-1/2	0.010	0005106300
1	4-1/2	0.010	0005106400
1-1/4	4-1/2	0.012	0005106500
1-1/2	4-1/2	0.012	0005106600
1-3/4	4-1/2	0.012	0005106700
2	4-1/2	0.012	0005106800
2-1/4	4-1/2	0.012	0005106900
2-1/2	4-1/2	0.012	0005107000
2-3/4	4-1/2	0.014	0005107100
3	4-1/2	0.014	0005107200
3-3/4	4-1/2	0.016	0005107400

Crimped Wire Tube Brush–Double Stem, Double Spiral



Constructed of premium steel or stainless steel filament in a variety of brush diameters, Osborn Crimped Wire Tube Brushes offer exceptional internal cleaning and surface preparation capabilities. Double stem and double spiral design offers ruggedness and versatility, and can be used as a hand tool, mounted in a drill press, or on a portable power tool.

Applications: Internal cleaning, removal of small imperfections, surface preparation

Brush Diameter	Brush Area Length	Stem Diameter	Fill Diameter	Overall Length	Item Number
Steel					
3/8	1-1/2	0.124	0.003	4	0005101900
1/2	2	0.187	0.004	5	0005102000
1/2	2	0.187	0.006	5	0005102100
5/8	2	0.208	0.006	5	0005102200
5/8	2	0.208	0.008	5	0005102300
5/8	2	0.208	0.010	5	0005102400
3/4	2-1/2	0.238	0.006	5	0005102500
3/4	2-1/2	0.238	0.010	5	0005102700
7/8	2-1/2	0.238	0.006	5	0005102800
7/8	2-1/2	0.238	0.010	5	0005103000
1	2-1/2	0.238	0.006	5	0005103100
1	2-1/2	0.238	0.010	5	0005103300
1-1/4	2-1/2	0.238	0.010	5	0005103700
1-1/2	2-1/2	0.238	0.010	5	0005103800
2	2-1/2	0.238	0.010	5	0005103900
Stainless Steel					
1/2	2	0.187	0.004	5	0005109100
5/8	2	0.208	0.006	5	0005108800
5/8	2	0.208	0.010	5	0005109000
3/4	2-1/2	0.238	0.010	5	0005109300
7/8	2-1/2	0.238	0.010	5	0005109600
1	2-1/2	0.238	0.010	5	0005109900
1-1/4	2-1/2	0.238	0.010	5	0005108500
1-1/2	2-1/2	0.238	0.010	5	0005108600
2	2-1/2	0.238	0.010	5	0005108700

Green TY™ Encapsulated Tube Brush–Double Stem, Double Spiral



This high quality Osborn brush features the versatility of a crimped wire tube brush with the added strength of TY™ elastomer encapsulation. The green (standard duty) elastomer supports wire strands to provide a stronger brushing action and longer brush life. Ideal for internal cleaning, imperfection removal and surface preparation.

Applications: Internal cleaning, removal of small imperfections, surface preparation

Brush Diameter	Brush Area Length	Fill Diameter	Overall Length	Item Number
Steel				
1/2	2	0.006	5	0005111000
5/8	2	0.010	5	0005111100
3/4	2-1/2	0.010	5	0005111200
7/8	2-1/2	0.010	5	0005111300
1	2-1/2	0.010	5	0005111400
Stainless Steel				
3/4	2-1/2	0.010	5	0005112200

Crimped Wire Spiral Tube Brush–Single Stem, Single Spiral



This small diameter crimped wire brush is designed to tackle a wide variety of internal cleaning jobs. Available with choice of steel or stainless steel filament for use on hand tools, drill presses and power tools, Osborn Wire Spiral Tube Brushes are designed for optimal performance and longevity.

Brush Diameter	Brush Area Length	Fill Diameter	Overall Length	Item Number
Steel				
1/4	1	0.005	3-1/2	0003670000
5/16	1	0.005	3-1/2	0003670400
3/8	1	0.005	3-1/2	0003670800
3/8	1	0.008	3-1/2	0003670900
1/2	1	0.005	3-1/2	0003671600
1/2	1	0.008	3-1/2	0003671700
9/16	1	0.005	3-1/2	0003672000
5/8	1	0.005	3-1/2	0003672400
5/8	1	0.008	3-1/2	0003672500
11/16	1	0.005	3-1/2	0003672800
3/4	1	0.005	3-1/2	0003673200
3/4	1	0.008	3-1/2	0003673300
13/16	1	0.005	3-1/2	0003673600
1	1	0.005	3-1/2	0003674800
1	1	0.008	3-1/2	0003674900
1-1/4	1	0.008	3-1/2	0003675700
1-1/2	1	0.005	3-1/2	0003676000
1-1/2	1	0.008	3-1/2	0003676100

Crimped Wire Tube Brush–Single Stem, Single Spiral



This small diameter crimped wire brush is designed to tackle a wide variety of internal cleaning jobs. Available with choice of steel or stainless steel filament for use on hand tools, drill presses and power tools, Osborn Wire Spiral Tube Brushes are designed for optimal performance and longevity.

Applications: Cleaning and deburring tubes, pipes, brake parts, fuel injectors

Brush Diameter	Brush Area Length	Stem Diameter	Fill Diameter	Overall Length	Item Number
Steel					
3/16	1-1/2	0.094	0.004	7	0005100100
3/16	1-1/2	0.094	0.006	7	0005100200
1/4	1-1/2	0.115	0.004	7	0005100300
1/4	1-1/2	0.115	0.006	7	0005100400
3/8	1-1/2	0.132	0.004	8	0005100500
3/8	1-1/2	0.168	0.006	8	0005100600
1/2	2	0.221	0.006	8	0005100700
1/2	2	0.221	0.008	8	0005100800
Stainless Steel					
3/16	1-1/2	0.094	0.006	7	0005108000
1/4	1-1/2	0.115	0.006	7	0005108100
3/8	1-1/2	0.168	0.006	8	0005108200
1/2	2	0.221	0.006	8	0005108300

Brass Wire Tube Brush–Single Stem, Single Spiral

Featuring straight brass wire filament and available in 1/8"–1" diameters, Osborn's Brass Wire Tube Brush provides uniform performance for a variety of internal cleaning and deburring jobs. Designed for use as a hand tool, mounted on a dress press, or on portable power tools.

Applications: Cleaning and deburring tubes, pipes



Brush Diameter	Brush Area Length	Stem Diameter	Fill Diameter	Overall Length	Item Number
Brass					
1/8	1	0.087	0.004	6	0005114100
1/4	1-1/2	0.087	0.004	7	0005114200
3/8	2	0.115	0.004	8	0005114300
1/2	2	0.115	0.004	8	0005114400
5/8	2-1/2	0.125	0.005	9	0005114500
3/4	2-1/2	0.125	0.005	9	0005114600
7/8	3	0.168	0.005	10	0005114700
1	3	0.168	0.005	10	0005114800

Sibot Internal Finishing Brush

This hard-working square-trimmed brush features rugged crimped steel wire to efficiently brush both the bottom and sides of a hole in a single operation. Provides quick, uniform cleaning of internal surfaces, and can be used in drill presses and portable tools. Ideal for removing fine burrs from the edges of cross-drilled holes and spot facing.

Applications: For removing fine burrs from the edges of cross-drilled holes, spot facing



Brush Diameter	Fill Diameter	Max RPM	Trim Length	Overall Length	Face Width	Item Number
Steel						
2	0.006	4,500	3/8	3-1/4	3/8	0001119000
2	0.006	4,500	13/32	3-5/8	3/8	0001119400
2	0.006	4,500	1/2	3-3/4	1/2	0001119800
2	0.006	4,500	9/16	3-3/4	1/2	0001120200
3	0.006	4,500	13/16	3-15/16	1/2	0001121000

Straight Wire Valve Guide Brush

Narrow diameter steel wire brush can be used as a hand tool, on a drill press, or on portable power tools. Ideal for cleaning valve guide bores or similar applications.

Applications: Cleaning valve guide bores



Brush Diameter	Brush Area Length	Stem Diameter	Fill Diameter	Overall Length	Item Number
Steel					
5/16	1-5/8	7/32	0.010	9-3/8	0005107500
3/8	1-5/8	7/32	0.010	3-3/8	0005107600

Brass Wire Tube Brush–Double Stem, Double Spiral



Designed with a double stem and double spiral for strength, this Brass Wire Tube Brush offers increased strength for more difficult internal cleaning jobs. Premium brass wire fill provides uniform performance when used as a hand tool, on a drill press, or on portable power tools. Ideal for mold cleaning and cleaning/deburring aluminum motor mounts.

Applications: Mold cleaning, cleaning and deburring aluminum motor mounts

Brush Diameter	Brush Area Length	Stem Diameter	Fill Diameter	Overall Length	Item Number
Brass					
1/4	1-1/2	0.124	0.005	4	0005114900
3/8	1-1/2	0.124	0.005	4	0005115000
1/2	2	0.163	0.005	5	0005115100
5/8	2	0.208	0.005	5	0005115200
3/4	2	0.208	0.006	5	0005115300
7/8	2-1/2	0.238	0.006	5-1/2	0005115400
1	2-1/2	0.238	0.006	5-1/2	0005115500

Nylon Tube/Spout Brush

Designed specifically as a hand tool, Osborn's Nylon Tube/Spout Brush features quality nylon fill and a handy eye loop. Ideal for cleaning engine blocks, heads, and other assorted parts during the engine rebuilding process.

Applications: Cleaning engine blocks, heads, and assorted parts during the engine rebuilding process



Brush Diameter	Brush Area Length	Stem Diameter	Fill Diameter	Overall Length	Item Number
Nylon					
1/4	2	3/32	0.005	6-1/4	0005110000
3/8	2	3/32	0.005	6-1/4	0005110100
1/2	3	3/32	0.008	8-1/2	0005110200
3/4	3	1/8	0.012	8-3/4	0005110300
1	5	5/32	0.010	15-1/2	0005110400
1-1/4	5	5/32	0.010	15-1/2	0005110500
1-1/2	5	7/32	0.010	15-1/2	0005110600
2	5	7/32	0.010	15-1/2	0005110800

Nylon Percolator Brush

Osborn's Nylon Percolator Brush features high quality 0.01" white nylon fill in a twisted wire stem/handle. Includes eye loop for convenient use as a hand tool. Ideal for cleaning internal percolator stems and similar applications.

Applications: Cleaning internal percolator stems



Brush Diameter	Brush Area Length	Stem Diameter	Overall Length	Item Number
Nylon				
7/16	3-1/2	1/8	11-1/2	0005110900

Miniature Brushes

Made in a variety of materials. Stainless steel and steel for delicate deburring; also available in brass and bristle for precise cleaning and fine polishing.

Miniature Wire Cup Brush

Osborn's Miniature Wire Cup Brushes provide precise, light-duty cleaning and deburring of small parts and pieces. Their small size also makes them ideal for tight, hard-to-reach areas. Premium quality construction provides exceptional lifespan.



Brush Diameter	Stem Diameter	Fill Diameter	Max RPM	Item Number
Steel				
9/16	1/8	0.003	25,000	0007570100
9/16	1/8	0.005	25,000	0007570500
Stainless Steel				
9/16	1/8	0.005	25,000	0007571000
Brass				
9/16	1/8	0.003	25,000	0007575900

Miniature Wheel Brush

Available with choice of wire or bristle, Osborn Miniature Wheel Brushes are designed to tackle a wide variety of light-duty cleaning and deburring projects. Wire models are ideal for delicate deburring tasks, while brass and bristle models buff and polish surfaces with absolute precision.



Brush Diameter	Stem Diameter	Fill Diameter	Max RPM	Item Number
Steel				
5/8	1/8	0.005	25,000	0007574900
3/4	1/8	0.003	25,000	0007575000
3/4	1/8	0.005	25,000	0007575300
1	1/8	0.005	25,000	0007576400
1-1/4	1/8	0.005	25,000	0007576800
1-1/2	1/8	0.005	25,000	0007577200
Stainless Steel				
5/8	1/8	0.005	25,000	0007575400
3/4	1/8	0.005	25,000	0007576000
1	1/8	0.005	25,000	0007575500
1-1/2	1/8	0.005	25,000	0007575600
Horse Hair				
3/4	3/32		25,000	0007571500
Brass				
3/4	3/32	0.005	25,000	0007575700
1	3/32	0.005	25,000	0007575800

Miniature Bristle Cup Brush

Constructed with choice of natural stiff or soft hair, Osborn Miniature Bristle Cup Brushes offer scratch-free surface cleaning of hard-to-reach areas. Can also be used with abrasive compound to buff and polish recessed surfaces.



Brush Diameter	Stem Diameter	Max RPM	Item Number
Horse Hair			
0.563	1/8	25,000	0007578000
1	1/8	25,000	0007578100
Bristle			
0.563	1/8	25,000	0007578200

Miniature Wire End Brush–Light Duty

Osborn's light duty Miniature Wire End Brushes feature small diameter, pencil-type ends for cleaning small holes and crevices. Premium construction provides longer brush life.



Brush Diameter	Brush Area Length	Stem Diameter	Fill Diameter	Overall Length	Item Number
Steel					
3/16	3/4	1/4	0.010	2-3/4	0003026100
1/4	3/8	5/16	0.006	2-3/8	0003026200
1/4	3/8	5/16	0.008	2-3/8	0003026300
Stainless Steel					
1/4	3/8	5/16	0.010	2-3/8	0003026500

Miniature Wire End Brush

Well-crafted with premium materials, Osborn Miniature Wire End Brushes feature fine crimped wire and a small brush diameter to make quick work of cleaning delicate parts, holes/crevices and ID's. Quality construction provides exceptionally long brush life.



Brush Diameter	Stem Diameter	Fill Diameter	Max RPM	Item Number
Steel				
3/16	1/8	0.003	25,000	0007566500
1/4	1/8	0.005	25,000	0007568000
5/16	1/8	0.005	25,000	0007569500
Stainless Steel				
3/16	1/8	0.003	25,000	0007567000
1/4	1/8	0.005	25,000	0007568500
5/16	1/8	0.005	25,000	0007570000
Brass				
3/16	1/8	0.003	25,000	0007567500
1/4	1/8	0.003	25,000	0007567700

Miniature Bristle End Brush

Trust Osborn Bristle End Brushes to buff and polish difficult-to-reach areas. Natural hair provides scratch-free finishing, making it ideal for delicate parts such as jewelry, optics, and other precision instruments.



Brush Diameter	Stem Diameter	Max RPM	Item Number
Horse Hair			
0.187	3/32	25,000	0007571700
0.25	3/32	25,000	0007571900
Goat Hair			
0.187	3/32	25,000	0007572400

X-Lock Power Brushes

The innovative Osborn attachment system for Bosch X-Lock angle grinders makes changing accessories a snap. Snap on and snap off grinder accessories 5 times faster without the use of additional tools. Just one click and you are ready to go!

Innovative solutions to your advantage

Osborn is focused upon producing the safest and highest quality products. Our patent pending systems provide the strongest and safest tool attachment, while being backward compatible when using conventional angle grinders.



Cutting Discs with X-Lock Adapter

Sandwich construction (patent pending)

- The attachment ring sandwiched between the fiberglass and abrasive layers providing the strongest and safest bond
- The patent pending construction process provides superior stability and vibration control

X-Lock abrasives can be found on page 87

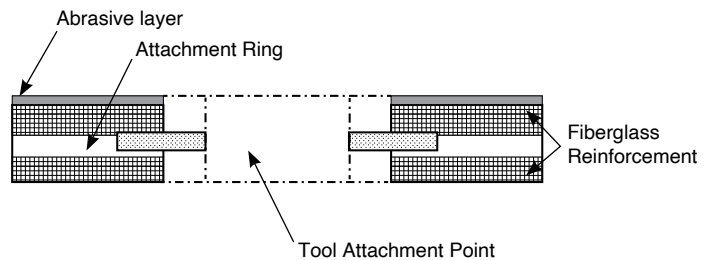

5/8" – 11 Thread and X-Lock Adapter

Combi-adapter (patent pending)

- Osborn brushes feature a combi-adapter allowing them to be backward compatible with conventional angle grinders
- One tool compatible with two devices

Professional X-Lock Brushes

Knotted Cup Brush

Best for heavy-duty and rigorous jobs now available in X-lock.

Diameter	Fill Diameter	Trim Length	Combi Thread	Qty/Box	Part No.
Steel					
2-1/2	0.014	3/4	5/8-11NC	1	0804608131
2-1/2	0.020	3/4	5/8-11NC	1	0804608151
Stainless Steel					
2-1/2	0.014	3/4	5/8-11NC	1	0804608331
2-1/2	0.020	3/4	5/8-11NC	1	0804608351



Knotted Radial Brush

Osborn's knotted Radial Brush now available in X-lock for an efficient delivery and uniform results.

Diameter	Fill Diameter	Trim Length	Combi Thread	Qty/Box	Part No.
Steel					
5	0.014	1	5/8-11NC	1	0804631131
5	0.020	1	5/8-11NC	1	0804631151
Stainless Steel					
5	0.014	1	5/8-11NC	1	0804631351
5	0.020	1	5/8-11NC	1	0804631331



Knotted Bevel Brush

Backwards compatible for regular hand tools or your X-lock grinder, Osborn's bevel brush features the ideal shape for brushing hard-to-reach areas.

Diameter	Fill Diameter	Trim Length	Combi Thread	Qty/Box	Part No.
Steel					
4	0.014	7/8	5/8-11NC	1	0804622131
4	0.020	7/8	5/8-11NC	1	0804622151



Crimped Cup Brush

The X-Lock technology added for efficient cleaning of large metal surfaces.

Diameter	Fill Diameter	Trim Length	Combi Thread	Qty/Box	Part No.
Steel					
2-1/2	0.011	3/4	5/8-11NC	1	0804613162
Stainless Steel					
2-1/2	0.011	3/4	5/8-11NC	1	0804613362





Abrasives

General Information	70–71
Cut-off Wheels	72–74
Grinding Wheels	75–77
Combo Cut/Grind Wheels	78–79
Flap Discs	80–83
Polimaxx Polishing	
Flap Discs	84
X-Lock Abrasives	85–87

Finding the Right Abrasive Solution

At Osborn, we take pride in delivering results. We believe in innovation. Our deep understanding of applications and strong Research and Development system drives us to bring these focuses together to create cutting-edge solutions for the end user—solutions that make a difference.

Copying a good idea is easy, but to bring a better option to the market is not. Determination, competence, focus, courage, thinking outside of the box, taking pride in results, and the ability to bring ideas to life are characteristics that deliver results, and make the daily grind worth it.

- Cut-Off Wheels
- Grinding Wheels
- Flap Discs

	Cut Off Wheels	Grinding Wheels	Flap Discs
Cutting	●●●		
Notching	●	●●	
Gouging		●●●	○
Fillet Weld Removal		●●●	●●
Beveling		●●●	●●
Scale Removal		○	●●●
Weld Removal		●●●	●●●
Contoured Areas		○	●●●

●●● Best Choice ●● Better ● Good ○ Suitable

Reading the Label

Osborn abrasives set the highest performance standard in the market. Our products are designed to take on the toughest cutting, grinding, blending, beveling, or deburring applications. Osborn's U.S. and Germany-based R&D and manufacturing teams work tirelessly to develop and manufacture products that deliver the performance you need—stronger, faster cutting, longer lasting, smoother cutting. The best raw materials, product designs, world class manufacturing, and R&D excellence come together in Osborn abrasives, and bring performance to the pros who demand the most.



Cut Off Wheels

Osborn's cut-off wheel range features a rugged reinforced design that helps the user cut faster for longer in portable and fixed-base cut off applications. Manufactured in a state-of-the-art single cavity press, quality and consistency is guaranteed in every wheel. Select from our range of sizes, styles, and premium quality abrasive materials for your cutting application.

Find the Right Wheel

	A		A+		EXT	
Abrasive Type	Aluminium Oxide		Advanced Aluminium Oxide		Ceramic	
Grain Size / Coarseness	60	46	60	46	60	46
Life	●	●	●●	●●	●●●	●●●
Cut Speed	●	●●	●	●●	●●●	●●●
Smooth Cut	●●	●	●●	●	●●●	●●
Application Materials						
Unalloyed & Alloyed Construction Steel	●	●	●●	●●	●●●	●●●
Very Solid Construction Steel	●	●	●●	●●	●●●	●●
Tool Steel	●	●	●●	●●	●●●	●●
High-Alloy Special Steel	●●	●●	●●	●●	●●●	●●●
Angular Steel Profiles	●●	●●	●●	●●	●●●	●●●
Angular Stainless Steel Profiles	●●	●●	●●	●●	●●	●●
Casts	○	○	●	●	●●	●●
Aluminium Alloy	●●	○	●	●	●●	●●
Copper	●●	○	●	●	●●	●●
Brass/Bronze	●●	○	●	●	●●	●●

●●● Best Choice ●● Better ● Good ○ Suitable

Type 1



Flat-cut-off wheels are used for a majority of general cutting applications. Perfect for sheet metal, tube stock, bar stock, and much more.

Type 27



Depressed center-cut-off wheels are used when a completely flush cut is required. The depressed center pushes the cutting edge away from the grinder, allowing for applications such as cutting a bolt head to be performed with ease.

Cutoff Wheel–A

Osborn's aluminum oxide cutoff wheels are engineered to endure the toughest cutting applications by offering a smooth cut on various materials.

Diameter	Thickness	Grit	Arbor Hole	Max RPM	Item Number
Type 01					
4.5	0.04	60	7/8	13,280	1111240572
4.5	0.045	60	7/8	13,280	1111250572
5	0.045	60	7/8	12,200	1120240572
6	0.04	60	7/8	10,200	1151240572
6	0.045	60	7/8	10,200	1151250572
Type 27					
4.5	0.045	60	5/8-11	13,280	1113250072R
5	0.045	60	7/8	12,200	1122240572
7	0.06	46	5/8-11	8,600	1183250072R
7	0.06	46	7/8	8,600	1183250572



Cutoff Wheel–A+

Get a long life cutoff wheel with Osborn's advanced aluminum oxide: your best choice for stainless steel cutting applications.

Diameter	Thickness	Grit	Arbor Hole	Max RPM	Item Number
Type 01					
4.5	0.04	60	7/8	13,280	1111246572
4.5	0.045	60	7/8	13,280	1111251572
5	0.045	60	7/8	12,200	1121240572
6	0.045	60	7/8	10,200	1151246572
Type 27					
4.5	0.045	46	5/8-11	13,280	1113251072R
4.5	0.045	60	7/8	13,280	1113251572
5	0.045	60	7/8	12,200	1123240572
7	0.06	46	5/8-11	8,600	1183251072R
7	0.06	46	7/8	8,600	1183251572



Cutoff Wheel–EXT

Maximum performance while running at lower temperatures which protects sensitive work materials from damage.

Diameter	Thickness	Grit	Arbor Hole	Max RPM	Item Number
Type 01					
4.5	0.045	60	7/8	13,280	1111500572
5	0.045	60	7/8	12,200	1121500572
5	0.06	46	7/8	12,200	1121512572
6	0.06	46	7/8	10,200	1153511572



Grinding Wheels

For the toughest stock removal and roughest blending applications, the Osborn grinding wheel range will help you get the job done right. Available in various styles, sizes, grit specs, and abrasive types, we have your needs and applications covered.

Find the Right Wheel

	A	AS	Z	EXT
Abrasive Type	Aluminium Oxide	Advanced Aluminium Oxide	Zirconia	Ceramic
Life	●	●	●●	●●
Speed	●	●	●●	●●●
Heat	●	●●	●●	●●●
Consistency of Performance Through Life	●	●	●●	●●●
Contaminant Free Stainless Cutting		●●●	●●●	●●●
Application Materials				
Unalloyed & Alloyed Construction Steel	●●	●	●●	●●●
Very Solid Construction Steel	●	●	●●	●●
Tool Steel	●	●	●●	●●
High-Alloy Special Steel		●●	●●	●●●
Sheet Steel	●●	●	●●	●●
Stainless Sheet Steel		●●	●●	●●●
Welding Seams	●●	●	●●●	●●●
Cast	○	●	●●	●●
Non-Ferrous Metals	●	○	●●	●●

●●● Best Choice ●● Better ● Good ○ Suitable

Type 27



Depressed center-grinding wheels are designed to keep the flange away from the surface material, thus, protecting the surface from unwanted scratching.

Grinding Wheel-A

The best-seller with brilliant price/performance ratio shows the best results on every angle grinder.

Diameter	Thickness	Grit	Arbor Hole	Max RPM	Item Number
Type 27					
4.5	0.25	24	5/8-11	13,280	3116520072R
4.5	0.25	24	7/8	13,280	3116520572
5	0.25	24	5/8-11	12,200	3126520072R
5	0.25	24	7/8	12,200	3126520572
6	0.25	30	7/8	10,200	3156041572
7	0.25	24	7/8	8,600	3186520572



Grinding Wheel-AS

The great quality of aluminum oxide grinding wheels also available for stainless steel applications.

Diameter	Thickness	Grit	Arbor Hole	Max RPM	Item Number
Type 27					
4.5	0.25	24	5/8-11	13,280	3116540072R
4.5	0.25	24	7/8	13,280	3116540572
5	0.25	24	7/8	12,200	3126540572
6	0.25	30	7/8	10,200	3156520572
7	0.25	24	5/8-11	8,600	3186540072R
7	0.25	24	7/8	8,600	3186540572



Grinding Wheel-EXT

Life, speed and performance all in one grinding wheel. Lower running temperature to protect sensitive materials.

Diameter	Thickness	Grit	Arbor Hole	Max RPM	Item Number
Type 27					
4.5	0.25	24	5/8-11	13,280	3117560072R
4.5	0.25	24	7/8	13,280	3117560572
5	0.25	24	7/8	12,200	3127561572
7	0.25	24	7/8	8,600	3187560572



Grinding Wheel-Z

For the toughest, hardest jobs, use Osborn zirconia grinding wheels. Formulated for long life and the ability to handle extremely difficult applications.

Diameter	Thickness	Grit	Arbor Hole	Max RPM	Item Number
Type 27					
4.5	0.25	30	7/8	13,280	3116560572
5	0.25	30	7/8	12,200	3126560572
6	0.25	30	5/8-11	10,200	3156560072R
6	0.25	30	7/8	10,200	3156560572
7	0.25	30	7/8	8,600	3186560572



Combo Cut/ Grind Wheels

Osborn's Advanced Aluminum Oxide or Ceramic combo wheels provide the best of both worlds when cutting, notching, and grinding need to be performed in one operation. Specially designed 1/8" thick wheels are the preferred option for cleaning root pass welds during pipeline construction.

Find the Right Wheel

	A+	EXT
Abrasive Type	Advanced Aluminium	Ceramic
Life	●	●●
Speed	●	●●
Heat	●●	●●
Consistency of Performance Through Life	●	●●
Mill Scale Removal	●●●	●●●

●●● Best Choice ●● Better ● Good ○ Suitable

Type 27



Depressed center-grinding wheels are designed to keep the flange away from the surface material, thus, protecting the surface from unwanted scratching.

Pipeline Grinding Wheel–A+

Diameter	Thickness	Grit	Arbor Hole	Max RPM	Item Number
Type 27					
4.5	0.125	46	5/8-11	13,280	1113270072R
4.5	0.125	46	7/8	13,280	1113270572
5	0.125	46	5/8-11	12,200	1123270072R
5	0.125	46	7/8	12,200	1123270572
6	0.125	46	7/8	10,200	1153270572



Pipeline Grinding Wheel–EXT

Diameter	Thickness	Grit	Arbor Hole	Max RPM	Item Number
Type 27					
4.5	0.125	36	5/8-11	13,280	3113551072R
4.5	0.125	36	7/8	13,280	3113551572
5	0.125	36	7/8	12,200	3123551572



Flap Discs

The most versatile surface finishing and shaping abrasive product is the flap disc. Osborn flap discs will save you time and money by delivering the performance of grinding wheels and fiber discs in one product. Remove material quickly and leave a nice finish, all in one step. Select from Osborn's self-sharpening abrasive options Zirconia or our Ceramic EXT series to find the best combination of speed, life, and finish for your application.

Find the Right Disc

	Z	EXT
Abrasive Type	Zirconia	Ceramic
Life	●●	●●●
Speed	●●	●●●
Heat	●●	●●●
Consistency of Performance Through Life	●●	●●●
Mill Scale Removal	●	●
Application Materials		
Unalloyed & Alloyed Construction Steel	●●●	●●
Very Solid Construction Steel	●●●	●●
Tool Steel	●●	●●●
High-Alloy Special Steel	●●	●●●
Sheet Steel	●●●	●●
Stainless Sheet Steel	●●	●●●
Welding Seams	●●●	●●●
Cast	●●	●●
Non-Ferrous Metals	●●	●●●
Wood	●	●
Plastic	●	●
Filling Compound	●	●

●●● Best Choice ●● Better ● Good ○ Suitable

Type 27



Flat-flap discs are the best choice for blending, smooth finishing, and edge honing.

Type 29



Conical-flap discs are the best choice for aggressive stock removal. The angle of the flap disc pairs with the natural holding angle of the grinder, resulting in maximum surface contact for stock removal on flat surfaces.

Flap Disc-EXT

Osborn's ceramic flap discs run at lower temperatures to allow for work on sensitive materials as well as on exotic metals.



Diameter	Grit	Arbor Hole	Max RPM	Item Number
Type 27				
4.5	40	7/8	13,280	5211434572
4.5	60	7/8	13,280	5211436572
4.5	80	7/8	13,280	5211437572
7	40	7/8	8,600	5218434572
7	60	7/8	8,600	5218436572
7	80	7/8	8,600	5218437572
Type 29				
4.5	40	5/8-11	13,280	5211444072R
4.5	40	7/8	13,280	5211444572
4.5	60	5/8-11	13,280	5211446072R
4.5	60	7/8	13,280	5211446572
4.5	80	5/8-11	13,280	5211447072R
4.5	80	7/8	13,280	5211447572
4.5	120	5/8-11	13,280	5211449072R
5	40	7/8	12,200	5212444572
5	60	7/8	12,200	5212446572
5	80	7/8	12,200	5212447572
5	120	7/8	12,200	5212449572
6	40	5/8-11	10,200	5215444072R
6	40	7/8	10,200	5215444572
6	60	5/8-11	10,200	5215446072R
6	60	7/8	10,200	5215446572
6	80	5/8-11	10,200	5215447072R
6	80	7/8	10,200	5215447572
6	120	5/8-11	10,200	5215449072R
6	120	7/8	10,200	5215449572
7	40	5/8-11	8,600	5218444072R
7	40	7/8	8,600	5218444572
7	60	5/8-11	8,600	5218446072R
7	60	7/8	8,600	5218446572
7	80	5/8-11	8,600	5218447072R
7	80	7/8	8,600	5218447572
7	120	5/8-11	8,600	5218449072R

HD Flap Disc-EXT

Osborn HD Ceramic Flap Discs are thicker and feature more flaps which provide an even longer life than regular Flap Discs.



Diameter	Grit	Arbor Hole	Max RPM	Item Number
Type 29				
4.5	40	5/8-11	13,280	5211474072R
4.5	40	7/8	13,280	5211474572
4.5	60	5/8-11	13,280	5211476072R
4.5	60	7/8	13,280	5211476572
4.5	80	7/8	13,280	5211477572
4.5	120	7/8	13,280	5211479572
5	40	7/8	12,200	5212474572
5	60	7/8	12,200	5212476572
5	80	7/8	12,200	5212477572
5	120	7/8	12,200	5212479572

Osborn HD flap discs provide **30–40% more life** than standard flap discs.

Flap Disc-Z

The most popular and versatile flap disc for a wide range of blending and finishing applications.



Diameter	Grit	Arbor Hole	Max RPM	Item Number
Type 27				
4.5	40	7/8	13,280	5211184572
4.5	60	7/8	13,280	5211186572
4.5	80	7/8	13,280	5211187572
7	40	7/8	8,600	5218184572
7	60	7/8	8,600	5218186572
7	80	7/8	8,600	5218187572
Type 29				
4.5	40	5/8-11	13,280	5211384072R
4.5	40	7/8	13,280	5211384572
4.5	60	5/8-11	13,280	5211386072R
4.5	60	7/8	13,280	5211386572
4.5	80	5/8-11	13,280	5211387072R
4.5	80	7/8	13,280	5211387572
4.5	120	5/8-11	13,280	5211389072R
5	40	7/8	12,200	5212384572
5	60	7/8	12,200	5212386572
5	80	7/8	12,200	5212387572
5	120	7/8	12,200	5212389572
6	40	5/8-11	10,200	5215384072R
6	40	7/8	10,200	5215384572
6	60	5/8-11	10,200	5215386072R
6	60	7/8	10,200	5215386572
6	80	5/8-11	10,200	5215387072R
6	80	7/8	10,200	5215387572
6	120	5/8-11	10,200	5215389072R
6	120	7/8	10,200	5215389572
7	40	5/8-11	8,600	5218344072R
7	40	7/8	8,600	5218384572
7	60	5/8-11	8,600	5218346072R
7	60	7/8	8,600	5218386572
7	80	7/8	8,600	5218387572

HD Flap Disc-Z

The combination of aggressive grinding power, excellent blending and better surface finishing ability.



Diameter	Grit	Arbor Hole	Max RPM	Item Number
Type 29				
4.5	40	5/8-11	13,280	5211454072R
4.5	40	7/8	13,280	5211454572
4.5	60	5/8-11	13,280	5211456072R
4.5	60	7/8	13,280	5211456572
4.5	80	5/8-11	13,280	5211457072R
4.5	80	7/8	13,280	5211457572
4.5	120	5/8-11	13,280	5211459072R
4.5	120	7/8	13,280	5211459572
5	40	7/8	12,200	5212454572
5	60	7/8	12,200	5212456572
5	80	7/8	12,200	5212457572
5	120	7/8	12,200	5212459572

Polimaxx Polishing Flap Disc

The Osborn Polimaxx polishing flap disc line-up is your one stop shop to tackle tasks from mill scale and paint removal all the way to a flawless mirror finish. Premium quality fleece from coarse to fine grit descales and blends with ease. High quality felt paired with polishing compound will create a high gloss finish.

Applications: Descale, rust removal, paint removal, blending, finishing, preparing and polishing weld seams, remove thermal bluing



Diameter	Arbor Hole	Type	Max RPM	Grit	Part No.
4-1/2	7/8	T29	13,280	Coarse	5541204572
4-1/2	7/8	T29	13,280	Medium	5541206572
4-1/2	7/8	T29	13,280	Fine	5541207572
4-1/2	7/8	T29	13,280	High Gloss Polishing Felt	5541220572

Fleece Options



Coarse



Medium



Fine



High Gloss

X-Lock Abrasives

The innovative Osborn attachment system for Bosch X-Lock angle grinders makes changing accessories a snap. Snap on and snap off grinder accessories 5 times faster without the use of additional tools. Just one click and you are ready to go!

Innovative solutions to your advantage

Osborn is focused upon producing the safest and highest quality products. Our patent pending systems provide the strongest and safest tool attachment, while being backward compatible when using conventional angle grinders.



Cutting Discs with X-Lock Adapter

Sandwich construction (patent pending)

- The attachment ring sandwiched between the fiberglass and abrasive layers providing the strongest and safest bond
- The patent pending construction process provides superior stability and vibration control

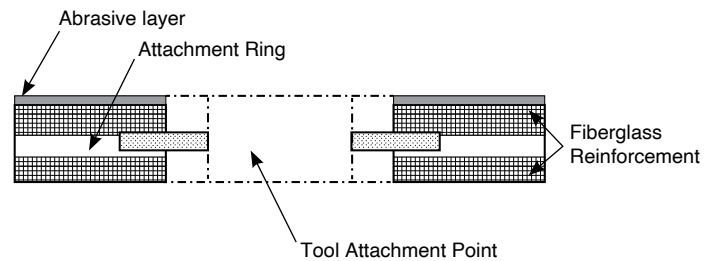

5/8" – 11 Thread and X-Lock Adapter

Combi-adapter (patent pending)

- Osborn brushes feature a combi-adapter allowing them to be backward compatible with conventional angle grinders
- One tool compatible with two devices

X-Lock power brushes can be found on page 68

Cut-Off Wheels

The same high quality of Osborn's aluminum oxide cutoff wheels now featuring X-lock system.

Diameter	Thickness	Grit	Grade*	Max. RPM	Qty/Box	Item Number
Type 01						
4.5	0.040	60	A	13,280	25	1911240572
4.5	0.045	46	A	13,280	25	1911250572
5	0.045	60	A	12,200	25	1921240572
4.5	0.040	60	A+	13,280	25	1911246572
4.5	0.045	46	A+	13,280	25	1911251572
5	0.045	60	A+	12,200	25	1921246572

* A: Aluminum Oxide, A+/AS: Advanced Aluminum Oxide, Z: Zirconia



Grinding Wheels

Flat surface grinding is now possible with the X-lock attachment.

Diameter	Thickness	Grit	Grade*	Max. RPM	Qty/Box	Item Number
Type 01						
4.5	0.25	24	A	13,280	10	3916040572
5	0.25	24	A	12,200	10	3926040572
4.5	0.25	24	AS	13,280	10	3916540572
5	0.25	24	AS	12,200	10	3926540572

* A: Aluminum Oxide, A+/AS: Advanced Aluminum Oxide, Z: Zirconia



Trimable Flap Discs

X-LOCK Flap Discs built on a plastic backer that can be trimmed as they wear to introduce fresh flaps.

Diameter	Grit	Grade*	Max. RPM	Qty/Box	Item Number
Type 27					
4.5	40	Z	13,280	10	5831184572
4.5	60	Z	13,280	10	5831186572
4.5	80	Z	13,280	10	5831187572
4.5	120	Z	13,280	10	5831189572
5	40	Z	12,200	10	5832184572
5	60	Z	12,200	10	5832186572
5	80	Z	12,200	10	5832187572
5	120	Z	12,200	10	5832189572

* A: Aluminum Oxide, A+/AS: Advanced Aluminum Oxide, Z: Zirconia



Diamond Blades

Available in two types: universal, which can be used for construction type applications such as concrete and masonry; and stoneware.

Diameter	Application	Max. RPM	Qty/Box	Item Number
Type U4				
4.5	Universal	13,280	1	4914185572
5	Universal	12,200	1	4924185572
Type F5				
4.5	Stoneware	13,280	1	4915514572
5	Stoneware	12,200	1	4925514572





ATB™ Advanced Technology Brushing

General Information	89–95
Wheel Brushes	96–100
Disc Brushes	101–106
Cup/End Brushes	107–110
Internal/Microabrasive/ Miniature Brushes	111–116
NovoFlex Honing Tools	117–120
PCD Superabrasives	122–124

ATB™ Introduction and Technical Information

ATB™ filaments work like independent flexible files conforming to part contours while abrading edges and surfaces. ATB™ abrasive tools produce rapid, repeatable results, which decrease process costs and create a cleaner, more efficient, working environment.

These tools are specifically designed for mechanical finishing tasks such as: deburring, sharp edge removal, radiusing, edge contouring, de-fuzzing, surface refinement and conditioning, plateau finishing, blending imperfections, reduction of surface stresses and micro crack propagation, cleaning, polishing and surface wiping prior to inspection gauging.

Both external and internal surface areas are processed on a wide variety of materials which include but are not limited to: metallics, super alloys, plastics, composites, advanced composites, metal matrix, ceramics, wood, leather, and cloth.



ATB™ Nylon Abrasive Filaments

Osborn continues to remain on the leading edge of advanced technology through innovation. Osborn has engineered abrasive nylon into flexible abrasive tools, which are being implemented into today's highly refined finishing processes. Osborn's abrasive tools are designed to adapt with the times as most manual operations are rapidly being replaced by automatic machinery and equipment such as: CNC machine centers, robotics, flexible machining systems, special machinery, and finishing cells.

Osborn's ATB™ brush tools are made with heat stabilized nylon filaments impregnated with Silicon Carbide, Aluminum Oxide, Ceramic or Polycrystalline Diamond grit. Grit loading ranges from 10–40% by weight, offering a wide variety of filament choices.

Coolant:

ATB™ filaments are designed with heat stabilizers and are able to withstand most applications dry.

However, coolant is always recommended for applications on very thin parts, requiring high penetration, and/or high speeds. Coolant provides an ideal working environment for ATB™ filaments.

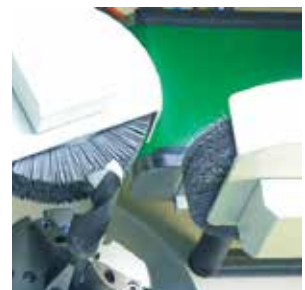

ATB™ Brush Tool Selection

Osborn's Advanced Technology Brushes are constructed with filaments that have a high density of abrasive grit for powerful deburring. They are designed for automatic machinery, equipment and hand tools. Osborn ATB™ brushes will improve your deburring processes, increase throughput and optimize your finishing results.

Tool Style Options

Osborn produces ATB™ brushes in five basic configurations.

Wheel Brushes

Wheel brushes are unidirectional finishing tools. The circumferential edge or "face" of this circular style brush performs the work. ATB™ wheel brushes are ideal for focused area work and are easily adaptable to standard shop equipment, highly specialized machinery, CNC machining centers and robot work cells. Osborn standard wheel brushes are produced in a full range of diameters, with a selection of operating face widths to perform almost any finishing task.

Disc Brushes

Disc brushes are a highly efficient tool for applications in which burred edges are on the same plane. Disc Brushes are multi-directional deburring tools working all part edges uniformly. They are easily adaptable to CNC machine centers, robot cells, and stationary finishing machines.

Cup Brushes

Cup brushes are efficient multi-directional deburring tools working all part edges uniformly. They are primarily used in off hand applications for maximum part coverage.

End Brushes

End brushes are ideal multi-directional tools for confined areas; this style is designed to have the ends of the fill strands do the bulk of the work.

Internal Finishing Brushes

Also known as a "side action" brush, this style is primarily used in CNC machines, portable tools and drill presses for cross hole deburring and fast cleaning and finishing of such inaccessible surfaces as small diameter bores and internally threaded surfaces.



ATB™ Brush Tool Selection

Abrasive Media Options:

- Silicon Carbide is characterized by a sharp jagged structure, and is the most popular grain choice because of its cost effective, efficient properties. (Color: gray/black. Hardness = 13 [MHOS Scale], Density = 3.25)
- Ceramic is characterized by a sharp jagged structure and extremely high fracture point. The blue ceramic filaments are the number one choice for deburring hardened and tougher materials.
- Aluminum Oxide is characterized by a rounded structure and produces a finer finish and prevents discoloration on certain alloys such as titanium, aluminum and stainless steel. (Color: tan/brown. Hardness = 12 [MHOS Scale], Density = 3.99)
- Polycrystalline Diamond (PCD) is characterized by a jagged structure. PCD is used to edge hone and radius super hard materials such as CBN and ceramics. (Hardness = 15 [MHOS scale])



Filament Geometry Options:

ATB™ abrasive tools feature four different filament geometries: round crimped, round straight, rectangular crimped, rectangular straight.



Round Crimped



Round Straight



Rectangular Straight



Rectangular Crimped

Round abrasive nylon filaments are impregnated with either Silicon Carbide, Ceramic or Aluminum Oxide grit. Grit sizes vary from coarse to very fine. This style is available in crimped or uncrimped form, and is also made in Alumina Silicate and Polycrystalline Diamond super abrasives.

- For general use
- Provides point contact—light to medium application technology
- Fine grit sizes are able to radius small corners
- Uncrimped filaments generate twice the abrasive contact on work surface
- Increased flexibility to conform to irregular surfaces

Rectangular Abrasive Nylon Filaments are impregnated with either Silicon Carbide, Ceramic or Aluminum Oxide and are offered in grit sizes ranging from coarse to fine.

- For high performance work
- Line contact—heavy duty application technology
- Applies approximately 18 times more abrasive on work surface
- Ideal on applications requiring more surface compliance without sacrificing the amount of abrasive in contact with the work surface
- Larger cross section allows the filament to be more rigid and aggressive
- Shorter cycle times
- Ability to remove micro chips and materials
- Excellent performance at lower rotational speeds

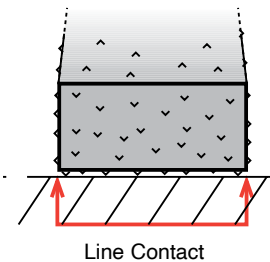
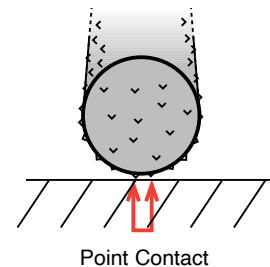

Filament & Grit Size Options

Smaller filaments with smaller grit size produce a finer finish and offer longer life. Larger filaments are more rigid and apply larger abrasive grit to the work piece with greater force and increased aggression. Grit sizes are available from 46–1000.

Crimped filaments offer better part conformability. Rectangular filaments offer higher aggression.

Shapes										
Sizes	mil	12	18	22	24	35	40	50	30x70	45x90
	mm	0.30	0.46	0.56	0.61	0.89	1.02	1.27	0.76 x 1.78	1.14 x 2.29
Grit Silicon Carbide (SC) Aluminium Oxide (AO)			SC	SC	SC	SC	SC	SC	SC	SC
		AO		AO	AO	AO	AO	AO	AO	AO
Mesh (USA Std.)		600	500	320	120	180	120	80	80 120 180 320 600	80 120 180 320 600

Color Grit Codes

- 60 white
- 80 red
- 120 yellow
- 180 green
- 240 brown
- 320 blue
- 500 orange
- 600 black
- 1000 purple

ATB™ brush tools are color coded for easy identification

Trim Length & Density Options

Trim Length refers to the length of the fill material that extends beyond the brush back or hub. A short trim makes a stiff, fast cutting brush, while a long trim gives the brush added flexibility that enables it to conform to irregular surfaces.

Fill Density is the number of filaments in the brushing surface. High density brushes produce finer surface finishes and are also used in deburring, or when fast cutting is required. Low density brushes offer greater flexibility, which increases its resiliency and ability to reach into confined areas and conform to uneven or contoured surfaces.



Long trim and light density are ideal for applications requiring a high degree of conformability



Short trim and high density are ideal for applications requiring increased aggression and minimal cycle time

ATB™ Brush Implementation

Optimal life and cut will be obtained by finding the proper balance between brush speed (RPM), part penetration, and line speed. The Maximum Safe Free Speed (MSFS) printed on the brush is not the ideal working speed. In most operations, a lower speed will prove more efficient. Optimal operating speed is typically 50–70% less than the MSFS. Lower speeds and lighter pressure give longer brush life, generate less heat, and require less power.

ATB™ Disc Brush Operating Parameters

Type	Dia. (in)	Brush Speed (RPM)				Penetration (in)						Feed (in/mm)					
		w/Coolant		Dry		Alum		Cast/Mild Steel		SS/Alloy		Alum		Cast/Mild Steel		SS/Alloy	
		Low	High	Low	High	Low	High	Low	High	Low	High	Low	High	Low	High	Low	High
Max. w/Bridge	0.5–1	4,300	7,500	3,800	7,000	0.03	0.06	0.03	0.13	0.03	0.18	36	44	24	43	15	33
	1.5–2.5	3,200	4,700	2,700	4,000	0.03	0.06	0.03	0.13	0.03	0.18	44	54	32	51	22	40
	3–4	2,500	3,500			0.03	0.06	0.03	0.13	0.03	0.18	52	67	42	60	31	48
	5–6	1,700	2,000			0.03	0.06	0.03	0.13	0.03	0.18	60	74	48	67	36	54
	7–8	1,300	1,500			0.03	0.06	0.03	0.13	0.03	0.18	68	84	56	75	43	61
	9–10	1,000	1,200			0.03	0.06	0.03	0.13	0.03	0.18	77	91	61	81	46	64
	12–14	800	1,000			0.03	0.06	0.03	0.13	0.03	0.18	84	98	65	85	50	68
Max.	0.5–1	3,000	6,200	2,500	5,000	0.03	0.06	0.03	0.13	0.03	0.18	23	35	17	30	11	24
	1.5–2.5	2,500	4,000	2,000	3,500	0.03	0.06	0.03	0.13	0.03	0.18	30	42	24	38	19	29
	3–4	2,000	2,700	1,500	2,500	0.03	0.06	0.03	0.13	0.03	0.18	37	50	30	45	22	36
	5–6	1,300	1,700	1,000	1,500	0.03	0.06	0.03	0.13	0.03	0.18	44	56	35	50	26	40
	7–8	1,000	1,100	850	1,000	0.03	0.06	0.03	0.13	0.03	0.18	50	62	40	56	30	45
	9–10	800	1,000	650	750	0.03	0.06	0.03	0.13	0.03	0.18	57	70	47	63	36	51
	12–14	600	700	450	550	0.03	0.06	0.03	0.13	0.03	0.18	64	76	51	68	39	54
Turbo	3–4	2,600	3,500	2,100	2,800	0.06	0.13	0.06	0.19	0.06	0.25	29	40	24	36	18	28
	5–6	1,700	2,100	1,400	1,600	0.06	0.13	0.06	0.19	0.06	0.25	35	44	28	40	21	32
	7–8	1,300	1,500	1,000	1,200	0.06	0.13	0.06	0.19	0.06	0.25	40	49	32	44	24	36
	9–10	1,000	1,100	850	1,000	0.06	0.13	0.06	0.19	0.06	0.25	45	56	37	50	28	40
	12–14	750	900	600	700	0.06	0.13	0.06	0.19	0.06	0.25	51	60	40	54	38	43
Tuftmatic	9–10	1,500	2,500	1,200	3,000	0.06	0.19	0.06	0.25	0.06	0.25	31	39	25	36	18	28
	12–14	1,200	1,700	1,000	1,400	0.06	0.19	0.06	0.25	0.06	0.25	36	44	28	39	21	32
	10	900	1,500	750	1,100	0.06	0.19	0.06	0.25	0.06	0.25	40	50	33	45	25	36
	12	770	1,200	650	950	0.06	0.19	0.06	0.25	0.06	0.25	42	52	34	46	30	37
	14	6550	1,000	550	800	0.06	0.19	0.06	0.25	0.06	0.25	45	54	36	48	34	38

- Rectangular filament should be run at the low end of the recommendation.
- Depth of penetration should be set while the brush tool is rotating at operational speed.
- Surface speeds should always be kept below 3500 surface speed per minute wet and 2500 surface speed per minute dry.



Class One
Micro burrs can only be seen with magnification



Class Two
Feather burrs can be seen without magnification. They can be removed with your fingernail.

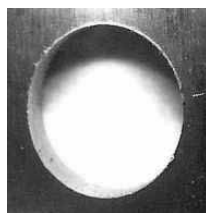

Class Three
Well attached small burrs are small in nature, but require a lot of force to be removed.



Class Four
Well attached large burrs are large in nature and have a larger attachment point than a Class Three burr.

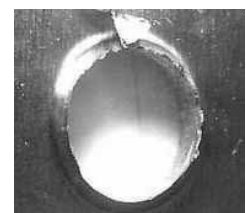

Class Five
Extruded burrs are very large burrs that extrude from the base material. These burrs need to be preconditioned before brushing.

ATB™ Brush Implementation

Tool Path Considerations:

For consistent results in an automated environment, careful consideration should be given when implementing ATB™ brush tools.

Tool Path:

The brush should start and finish its path completely off the part.



Rotational Direction:

The initial pass of the brush tool should be rotated in the direction opposite of the cutting tool that created the burr.

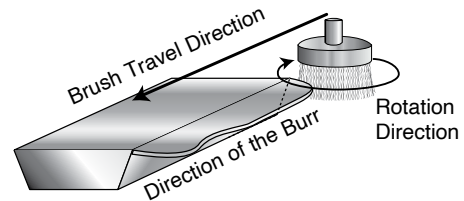

Part Coverage:

There are two different ways to efficiently finish a part. The ideal (Figure A) is to use a brush which is approximately three inches larger than the work piece. If a smaller brush is required due to application restrictions, (Figure B) the centerline of the brush tool should be aligned with the targeted edge.

Figure A

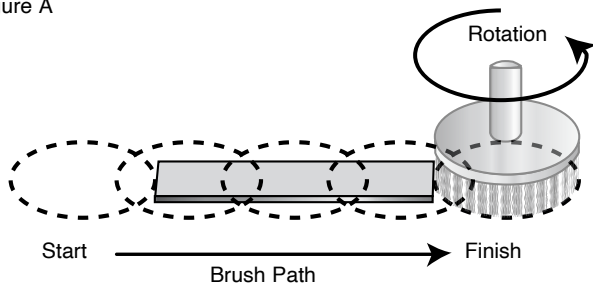
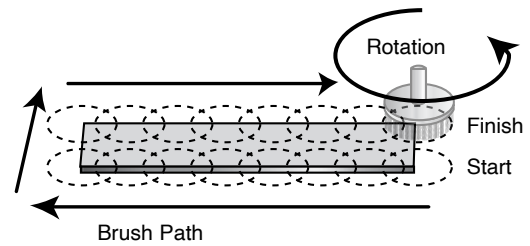

Figure B



Brush Tool Wear Compensation

The following are the four most commonly used methods to compensate for brush tool wear.

Automatic Indexing is a technique involving indexing the brush tool in the Z axis after a predetermined number of parts. It is a commonly used technique in CNC machining centers.

Probing is a technique that helps maintain a constant depth of penetration. It is a feature specific to certain machines.

Amperage (Amp) Metering is a technique that consistently monitors the amp reading to maintain consistent pressure. This feature requires the addition of an amp meter to the process.

Manual Indexing is a technique where the operator manually adjusts for wear on the brush using historical statistical data.

ATB™ Wheel Brush Penetration

ATB™ Filaments deburr and radius edges by drawing the filament sides across part edges. Optimum life and cut is obtained by finding the proper balance between brush speed (RPM), part penetration, dwell time, and abrasive grain size.

Correct Penetration

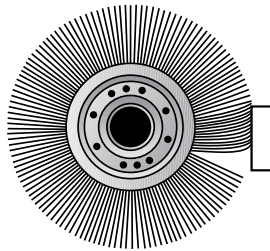

Incorrect Penetration

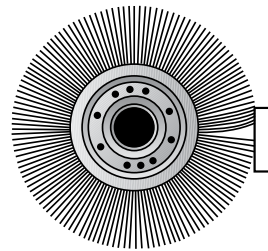

Suggested ATB™ Wheel Brush Operating Parameters

Diameter	RPM	Penetration
2"	4000–6000	0.125
3"	3000–4000	0.125
4"	2000–3000	0.125
6"	1500–2000	0.010
8"	1200–1800	0.125
10"	1000–1250	0.014
12"	800–1000	0.125
14"	700–900	0.125

Recommended Horse Power

Diameter	Horse Power	RPM
4"	1/4 HP	3000
6"	1/4 HP	2000
8"	3/4 HP	1800
10"	1 HP	1250
12"	1 HP	1000
14"	1 HP	900

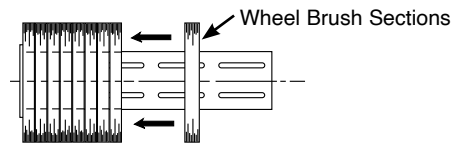

When using multiple brushes on a common shaft, multiply Horsepower (HP) with number of brushes (N). (HP x N)

ATB™ Wheel Brushes

Osborn provides a complete line of ATB™ Wheel Brushes including narrow and wide face, small ringlocks, and specialty treated configurations. The abrasive nylon filaments eliminate the need for cleaning finished parts. ATB™ Wheel Brushes are excellent for use on both metallic and non-metallic surfaces.

ATB Fascut™ Wheel Brush–Aggressive

Osborn's aggressive ATB Fascut™ Wheel Brush is designed with short trim, premium nylon filament that is impregnated with abrasive material. Features high density, uniformly distributed Round Crimped Silicon Carbide or Round Ceramic filaments for increased aggression, minimum cycle time, and the industry's longest brush life.

Applications: Steel gears, machine parts, stainless steel, hardened alloys, saw cut extrusions, powder metal components



Brush Diameter	Fill Diameter	Grit Size	Arbor Hole Diameter	Max RPM	Trim Length	Face Width	Item Number
Silicon Carbide							
6	0.018	500	2	3,600	1-1/4	1	0004062600
6	0.022	320	2	3,600	1-1/4	1	0004062500
6	0.024	120	2	3,600	1-1/4	1	0004062200
6	0.035	180	2	3,600	1-1/4	1	0004062400
6	0.040	80	2	3,600	1-1/4	1	0004062100
6	0.040	120	2	3,600	1-1/4	1	0004062300
8	0.022	320	2	3,600	1-1/4	1	0004059000
8	0.024	120	2	3,600	1-1/4	1	0004058700
8	0.040	80	2	3,600	1-1/4	1	0004058600
8	0.040	120	2	3,600	1-1/4	1	0004058800
10	0.040	120	4-1/4	3,600	1-1/4	1	0004053100
12	0.022	320	5-1/4	1,800	1-1/4	1	0004064900
Ceramic							
8	0.035	80	2	3,600	1-1/4	1	0004088600
8	0.043	120	2	3,600	1-1/4	1	0004088800



ATB Fascut™ Wheel Brush–Flexible

Osborn's flexible ATB Fascut™ Wheel Brushes feature long trim, flexible Round Crimped Silicon Carbide or Round Ceramic nylon abrasive filaments. Designed with moderate density, this brush is ideal for applications requiring a high degree of conformability. High-quality materials and construction offer the industry's longest brush life.



Applications: Turbine blades, indexable cutting tool inserts, cam shafts, gears, machined parts, edge radiusing

Brush Diameter	Fill Diameter	Grit Size	Arbor Hole Diameter	Max RPM	Trim Length	Face Width	Item Number
Ceramic							
6	0.026	120	2	3,600	1-1/4	1	0004082500
6	0.035	80	2	3,600	1-1/4	1	0004082100
6	0.043	120	2	3,600	1-1/4	1	0004082300
8	0.049	80	1-1/4	3,600	2-1/4	1	0004089600
Silicon Carbide							
8	0.022	320	1-1/4	3,600	2-1/4	1	0004059700
8	0.035	180	1-1/4	3,600	2-1/4	1	0004059600
8	0.040	80	1-1/4	3,600	2-1/4	1	0004059400
8	0.040	120	1-1/4	3,600	2-1/4	1	0004059500
10	0.022	320	2	3,600	2-1/16	1	0004054300
10	0.035	180	2	3,600	3	1	0004053700
10	0.040	80	2	3,600	2-1/16	1	0004054000
10	0.040	120	2	3,600	2-1/16	1	0004054100
12	0.022	320	4-1/4	1,800	3	1	0004065400
12	0.040	120	4-1/4	1,800	3	1	0004065200
14	0.022	320	5-1/4	1,800	3-5/8	2-1/2	0004016400
14	0.035	180	5-1/4	1,800	3-5/8	2-1/2	0004016300
14	0.040	80	5-1/4	1,800	3-5/8	1	0004019500
14	0.040	120	5-1/4	1,800	3-5/8	1	0004019200

ATB Master™ Wheel Brush

Featuring efficient Silicon Carbide or aggressive Ceramic abrasives and a wide face width, Osborn ATB Master™ Wheel Brushes are highly effective on both metallic and non-metallic materials. Cutting action does not require compound, eliminating the need to clean finished parts to save you time and money. Designed with premium Round Crimped nylon filaments to offer the industry's longest brush life. Brushes can be used singly, or can be mounted in multiples for larger surfaces.



Applications: Deburring, edge breaking, finishing

Brush Diameter	Fill Diameter	Grit Size	Arbor Hole Diameter	Max RPM	Trim Length	Face Width	Item Number
Silicon Carbide							
3	0.022	320	5/8	20,000	5/8	1/2	0002225100
3	0.022	320	5/8	20,000	5/8	7/8	0002225500
3	0.035	180	5/8	20,000	5/8	1/2	0002225000
3	0.035	180	5/8	20,000	5/8	7/8	0002225400
3	0.040	80	5/8	20,000	5/8	1/2	0002224800
3	0.040	80	5/8	20,000	5/8	7/8	0002225200
3	0.040	120	5/8	20,000	5/8	1/2	0002224900
3	0.040	120	5/8	20,000	5/8	7/8	0002225300
4	0.022	320	5/8	12,000	3/4	5/8	0002225900
4	0.035	180	5/8	12,000	3/4	5/8	0002225800
4	0.040	80	5/8	18,000	1-1/8	1/2	0002224000
4	0.040	80	5/8	18,000	1-1/8	7/8	0002224400
4	0.040	80	5/8	12,000	3/4	5/8	0002225600
4	0.040	120	5/8	12,000	3/4	5/8	0002225700
6	0.018	500	2	6,000	1-1/16	7/8	0002228900
6	0.022	320	2	6,000	1-1/16	7/8	0002228800
6	0.035	180	2	6,000	1-1/16	7/8	0002228700
6	0.040	80	2	6,000	1-1/16	7/8	0002228500
6	0.040	120	2	6,000	1-1/16	7/8	0002228600
8	0.018	500	2	4,500	1-1/2	7/8	0002230000
8	0.022	320	2	4,500	1-1/2	7/8	0002229900
8	0.035	180	2	4,500	1-1/2	7/8	0002229800
8	0.040	80	2	4,500	1-1/2	7/8	0002229600
8	0.040	120	2	4,500	1-1/2	7/8	0002229700
10	0.022	320	2	3,600	2-1/16	1	0002231500
10	0.035	180	2	3,600	2-1/16	1	0002231400
10	0.040	80	2	3,600	2-1/16	1	0002231200
10	0.040	120	2	3,600	2-1/16	1	0002231300
12	0.022	320	2	3,000	2-1/8	1	0002232800
12	0.035	180	2	3,000	2-1/8	1	0002232700
12	0.040	120	2	3,000	2-1/8	1	0002232500
12	0.040	120	2	3,000	2-1/8	1	0002232600
14	0.022	320	2	2,400	2-1/8	1	0002233600
14	0.035	180	2	2,400	2-1/8	1	0002233500
14	0.040	80	2	2,400	2-1/8	1	0002233300
14	0.040	120	2	2,400	2-1/8	1	0002233400
Ceramic							
3	0.026	120	5/8	20,000	5/8	1/2	0002251000
4	0.026	120	5/8	18,000	1-1/8	1/2	0002252000
4	0.026	120	5/8	12,000	3/4	5/8	0002252200
4	0.035	80	5/8	18,000	1-1/8	1/2	0002251400
4	0.035	80	5/8	18,000	1-1/8	7/8	0002251800
4	0.043	120	5/8	12,000	3/4	5/8	0002252300
4	0.055	80	5/8	18,000	1-1/8	1/2	0002251500
4	0.055	80	5/8	12,000	3/4	5/8	0002251700
4	0.055	80	5/8	18,000	1-1/8	7/8	0002251900
6	0.030	120	2	6,000	1-1/16	7/8	0002252700
6	0.035	80	2	6,000	1-1/16	7/8	0002252400
6	0.043	120	2	6,000	1-1/16	7/8	0002252800
14	0.030	120	2	2,400	2-1/8	1	0002253600
14	0.035	80	2	2,400	2-1/8	1	0002253300



ATB Monarch™ Wheel Brush

The highly versatile Osborn ATB Monarch™ Wheel Brush features premium Round Crimped nylon filaments with abrasive Silicon Carbide. Brush is narrow-faced with long trim, making it ideal for confined areas and irregular shapes. Quality materials and construction provides aggressive cutting power without sacrificing longevity.

Applications: Confined areas and irregular shapes, excellent for carbide insert edge honing, piston ring grooves, inside steel tanks, wood finishing



Brush Diameter	Fill Diameter	Grit Size	Arbor Hole Diameter	Max RPM	Trim Length	Face Width	Item Number
Silicon Carbide							
6	0.018	500	2	5,500	1-5/8	1/2	0002066900
6	0.022	320	2	5,500	1-5/8	1/2	0002066800
6	0.035	180	2	5,500	1-5/8	1/2	0002066700
6	0.040	80	2	5,500	1-5/8	1/2	0002066500
6	0.040	120	2	5,500	1-5/8	1/2	0002066600
8	0.022	320	2	5,500	2-5/8	1/2	0002064600
8	0.035	180	2	5,500	2-5/8	1/2	0002065400
8	0.040	120	2	5,500	2-5/8	1/2	0002066000
14	0.022	320	5-1/4	3,000	3-7/8	5/8	0002088400
14	0.035	180	5-1/4	3,000	3-7/8	5/8	0002088600
14	0.040	120	5-1/4	3,000	3-7/8	5/8	0002088700

ATB Ringlock™ Brush

Constructed with high-quality nylon filament with choice of Silicon Carbide or Ceramic abrasive, Osborn's small diameter ATB Ringlock™ Wheel Brushes are ideal for a variety of tasks using portable tools and drill presses. Silicon Carbide brushes tackle a variety of cleaning and deburring both ID and OD surfaces while Ceramic brushes are designed for more aggressive deburring applications. Brushes are expertly designed and tested to provide unmatched longevity.

Applications: Cleaning and polishing ID and OD surfaces. Deburring cross holes in large bearing bores, seal grooves in turbine engine cases and small aerospace parts.



Brush Diameter	Fill Diameter	Grit Size	Arbor Hole Diameter	Max RPM	Trim Length	Face Width	Item Number
Silicon Carbide							
1-1/2	0.022	320	1/2	20,000	1/4	1/4	0001114800
1-1/2	0.024	120	1/2	20,000	1/4	1/4	0001114600
1-1/2	0.035	180	1/2	20,000	1/4	1/4	0001114700
2	0.022	320	5/8	15,000	7/16	3/8	0001115100
2	0.024	120	5/8	15,000	7/16	3/8	0001114900
2	0.035	180	5/8	15,000	7/16	3/8	0001115000
2-1/2	0.022	320	5/8	15,000	11/16	3/8	0001115500
2-1/2	0.024	120	5/8	15,000	11/16	3/8	0001115300
2-1/2	0.035	180	5/8	15,000	11/16	3/8	0001115400
Ceramic							
1-1/2	0.026	120	1/2	20,000	1/4	1/4	0001133200
2	0.026	120	5/8	15,000	7/16	3/8	0001133300
2-1/2	0.026	120	5/8	15,000	11/16	3/8	0001133600
2-1/2	0.035	80	5/8	15,000	11/16	3/8	0001133700

ATB™ Disc Brushes

ATB™ Disc brushes are perfect for many applications in a variety of industries including automotive, woodworking, cutting tool, aircraft/aerospace, and general industrial use. Our adapters allow them to work easily with existing equipment. Osborn maintains our most popular configurations as standard stock items. A wide variety of specials can be made to order.

ATB™ Uni-Lok® Disc Brushes

Osborn's ATB™ Uni-Lok disc brushes are reliable, high-performance tools that produce consistent quality and cost effective results. These flexible, abrasive tools are selective in nature and preferentially deburr, radius corners and edges without changing critical dimensional tolerances.

The tools are easily integrated into today's automated machinery, CNC machining centers, transfer lines and robotic cells. Repeatable results, high through-put and adaptability to existing plant equipment make ATB™ metal finishing tools considered one of the most economical deburring methods on the market.

Disc Brush Configurations

Osborn maintains three configurations as standard stock options: max density, turbo and tufmatic. We also have the capability of providing customized products for a wide variety of applications. ATB™ Uni-Lok brushes fit most disc brush adapters.

ATB™ Uni-Lok®-Max Density

Osborn's maximum density design delivers maximum aggression for the most demanding applications. These tools are capable of processing large burrs and generating significant edge radii on stainless steel and hardened alloys without altering the part's dimension. Our maximum density allows for minimal cycle time and longer brush life.

ATB™ Uni-Lok®-Turbo

Osborn's unique turbo design draws air into the brush face allowing the brush to run cooler in dry applications. In wet applications, the turbo design allows for better coolant flow. These brushes are capable of handling moderate to severe burrs or where conformability is needed.

ATB™ Uni-Lok®-Tufmatic™

Osborn's Tufmatic design is constructed with a tough polypropylene base and precisely located staple set tufts. This density configuration allows the abrasive filaments to flow evenly and consistently over the most intricate flat faced parts. Osborn's tufmatic design allows for fast, accurate burr removal, precisely controlled edge radiusing and improved surface finishing. These tools are designed to be compatible with Osborn's Uni-Lok adapter system and are effective in both dry and wet applications.



ATB Uni-Lok® Max Density Disc Brush

Designed to tackle the most demanding of applications, Osborn's ATB Uni-Lok® Max Density Disc Brushes deliver maximum aggression and reliable, uniform performance. Brushes feature max density, premium quality Round Crimped abrasive nylon filament, making them capable of processing large burrs on stainless steel and hardened alloys without altering the part's dimension. Expertly designed and tested for minimal cycle time and exceptional brush life.

Applications: Engine block housing, airframe components, gears after machining/grinding, die cast parts after machining, cast aluminum automobile wheels, blending tool marks



Brush Diameter	Fill Diameter	Grit Size	Max RPM	Item Number
Silicon Carbide				
3	0.022	320	4,500	0004702500
3	0.024	120	4,500	0004702200
3	0.035	180	4,500	0004702400
3	0.040	80	4,500	0004702100
3	0.040	120	4,500	0004702300
4	0.024	120	3,500	0004702800
4	0.035	180	3,500	0004703000
4	0.040	80	3,500	0004702700
4	0.040	120	3,500	0004702900
4	0.045	80	3,500	0004702600*
5	0.022	320	3,000	0004703700
5	0.035	180	3,000	0004703600
5	0.040	80	3,000	0004703300
5	0.040	120	3,000	0004703500
5	0.045	80	3,000	0004703200*
6	0.035	180	2,500	0004704200
6	0.040	80	2,500	0004703900
6	0.040	120	2,500	0004704100
8	0.040	80	1,800	0004705100
8	0.040	120	1,800	0004705300
9	0.040	80	1,500	0004705700
9	0.040	120	1,500	0004705900
10	0.022	320	1,500	0004706700
10	0.035	180	1,500	0004706600
Ceramic				
4	0.043	120	3,500	0004750100
4	0.055	80	3,500	0004750300
6	0.035	80	2,500	0004750700
6	0.043	120	2,500	0004750600
6	0.055	80	2,500	0004750800

* 0.045x0.090 Rectangular Filament

ATB Uni-Lok® Turbo Disc Brush

Osborn's ATB Uni-Lok® Turbo Disc Brush features Round Crimped abrasive filaments in a unique turbo design to effectively tackle moderate to severe burrs or tasks where conformability is required. When used in dry applications, turbo design draws air into the brush face to run cooler. When used in wet applications, the turbo design allows more coolant to flow within the brushing surface.

Applications: Aluminum engine housing, engine components, fine blanked steel parts, pump housings



Brush Diameter	Fill Diameter	Grit Size	Max RPM	Item Number
Silicon Carbide				
3	0.022	320	4,500	0004708500
3	0.035	180	4,500	0004708400
3	0.040	80	4,500	0004708100
3	0.040	120	4,500	0004708300
4	0.040	80	3,500	0004708700
4	0.040	120	3,500	0004708900
5	0.040	120	3,000	0004709500
6	0.040	120	2,500	0004710100
8	0.040	120	1,800	0004711300
10	0.035	180	1,500	0004712600
10	0.040	80	1,500	0004712300
10	0.040	120	1,500	0004712500
Ceramic				
4	0.055	80	3,500	0004752100
4	0.043	120	3,500	0004752000
6	0.055	80	2,500	0004752400
6	0.043	120	2,500	0004752300



ATB Uni-Lok® Quick Change Brush

Osborn's ATB Uni-Lok® Quick Change Brushes feature a permanently mounted 1/4" shank for quick, convenient attachment to CNC machines, automatic equipment, portable tools, and robotic cells. These small diameter brushes feature premium-quality nylon filament with choice of Round Crimped Silicon Carbide or Round Ceramic abrasive to serve a variety of deburring needs. The unique composite design allows for "touching" of surrounding raised surfaces without harming the part or the brush. Designed and tested for longevity and uniformity.

Applications: Deburring and edge radiusing space restricted and recessed areas, larger bosses on cylinder heads, sensor ports on turbine engine cases and larger pockets in turbine engine combustion cases.



Brush Diameter	Fill Diameter	Grit Size	Max RPM	Trim Length	Item Number
Ceramic					
1	0.035	80	4,500	1	0004723400
1	0.043	120	4,500	1	0004723500
1-1/2	0.043	120	4,500	1-3/8	0004785500
2	0.035	80	4,500	1-3/8	0004785900
2	0.043	120	4,500	1-3/8	0004786000
2	0.055	80	4,500	1-3/8	0004786100
2-1/2	0.055	80	4,500	1-3/8	0004786600
3	0.043	120	4,500	1-3/8	0004724000
3	0.055	80	4,500	1-3/8	0004724100
Silicon Carbide					
1-1/2	0.022	320	4,500	1-3/8	0004725400
1-1/2	0.040	80	4,500	1-3/8	0004725100
1-1/2	0.040	120	4,500	1-3/8	0004725200
2	0.022	320	4,500	1-3/8	0004725900
2	0.040	80	4,500	1-3/8	0004725600
2	0.040	120	4,500	1-3/8	0004725700
2-1/2	0.022	320	4,500	1-3/8	0004726400
2-1/2	0.040	80	4,500	1-3/8	0004726100
2-1/2	0.040	120	4,500	1-3/8	0004726200

ATB Uni-Lok® Tuftmatic Disc Brush

Constructed with a durable polypropylene base and a dense configuration of strategically located tufts, Osborn ATB Uni-Lok® Tuftmatic™ Disc Brushes offer thorough, uniform performance in both dry and wet applications. Each tuft features high-quality nylon filaments impregnated with Silicon Carbide, and is configured to allow abrasive filaments to flow evenly and consistently over the most intricate flat-faced parts. Compatible with Osborn's Uni-Lok® adapter system and designed for maximum effectiveness.

Applications: Saw cut aluminum extrusions, heat sinks, machined parts, powdered metal parts, electronic aluminum housings, stamped parts, fineblanked steel parts, robotic deburring



Brush Diameter	Fill Diameter	Grit Size	Arbor Hole Diameter	Max RPM	Trim Length	Item Number
Silicon Carbide						
6	0.022	320	7/8	3,000	1	0004716300
6	0.028	120	7/8	3,000	1	0004716100
8	0.022	320	7/8	3,000	1	0004717500
10	0.028	120	7/8	3,000	1	0004718500

ATB Uni-Lok® Bridle

Improve the aggressiveness of Osborn's ATB™ Composite brushes with ATB Uni-Lok® Bridles. Sold in three packs, these Bridles are designed to significantly reduce the flare of filaments to increase rigidity for use on heavy-duty applications. Not for use on ATB™ turbo discs.



Brush Size	Compression	Cross Section	Bridle I.D.	Bridle O.D.	Bridle O.D. on brush	Part No.
1.50	0.38	0.13	1.13	1.38	1.66	0004714800
2.00	0.50	0.19	1.50	1.88	2.25	0004714000
2.50	0.50	0.19	2.00	2.38	2.75	0004714100
3.00	0.75	0.19	2.25	2.63	3.13	0004714200
4.00	0.75	0.19	3.25	3.63	4.20	0004714300
5.00	1.00	0.19	4.00	4.38	5.20	0004714400
6.00	1.00	0.25	5.00	5.50	6.30	0004714500

ATB Uni-Lok® Disc Brush Drive Arbor

Save time and increase efficiency with Osborn's ATB Uni-Lok® Disc Brush Drive Arbor. Compatible with all Osborn Uni-Lok® Brushes, the drive arbor features a single point fastening system for quick changeover. Features a 3/4" shank with screw flat. Design also allows coolant to flow through to maintain optimal brush performance.



Brush Diameter	Drive Hole Size & Location	Backing Plate Diameter	Part No.
3", 4" & 5"	(2) 1/4" Dia. On 1-1/4" bolt circle	3"	0004720000
6" & 7"	(3) 1/4" Dia on 3" bolt circle	6"	0004720100
8" & 9"	(4) 1/4" Dia on 3" bolt circle	8"	0004720200
10"	(4) 1/4" Dia. On 1-5/8" bolt circle	10"	0004720300

ATB™ Cup/ End Brushes

ATB™ cup brushes are heavily filled with nylon filaments. Filaments are impregnated with silicon carbide or aluminum oxide grit, ideal for surface finishing and deburring. ATB™ end brushes are frequently used for power transmission gear deburring, to fit into tight areas too small for wheels and discs. They are recommended for operations where balance is critical.

ATB™ Cup Brushes

ATB™ Cup Brush–Round Trim

Designed with a round trim and densely packed nylon filaments, this Osborn ATB™ Cup Brush offers optimal performance on irregular surfaces. Premium quality nylon filaments filled with Silicon Carbide abrasive to increase effectiveness and brush life.

Applications: Engine blocks, cylinder heads, exhaust manifolds, transmission housings, water pumps and intake manifolds, bulk heads, wing spars, engine housings and components, hydraulic valve bodies, machine components, housings, gears and castings



Brush Diameter	Fill Diameter	Grit Size	Arbor Hole Diameter	Max RPM	Trim Length	Item Number
Silicon Carbide						
4	0.022	320	5/8-11	6,000	1-1/2	0003212700
4	0.040	80	5/8-11	6,000	1-1/2	0003213700
4	0.040	120	5/8-11	6,000	1-1/2	0003212500
6	0.022	320	5/8-11	6,000	1-1/2	0003213300
6	0.040	80	5/8-11	6,000	1-1/2	0003213800
6	0.040	120	5/8-11	6,000	1-1/2	0003213100

ATB™ Cup Brush–Flat Trim

Featuring a precision cut flat trim and premium quality 0.045" x 0.090" rectangular nylon filaments, this Osborn ATB™ Cup Brush is ideal for flat surface finishing and deburring. Brushes are heavily filled with filaments impregnated with choice of Silicon Carbide or Aluminum Oxide and are designed for maximum longevity. Note: 4" brushes include premium quality bridle for maximum filament rigidity.

Applications: Hydraulic valve bodies, machine components, housings, gears and castings



Brush Diameter	Grit Size	Arbor Hole Diameter	Max RPM	Trim Length	Item Number
Silicon Carbide					
4	80	5/8-11	6,000	1-1/2	0003214800
6	80	5/8-11	6,000	2	0003213200
Aluminum Oxide					
4	120	5/8-11	6,000	1-1/2	0003214900

ATB™ Cup Brush with Shank

Constructed with a permanently attached 1/4" stem and reduced flare for increased rigidity, Osborn's ATB™ Cup Brush with Shank provides aggressive brush action on irregular or flat surfaces. Brush features round trimmed premium abrasive nylon filaments for multi-directional uniformity. Designed and tested for maximum longevity.

Applications: Engine blocks, cylinder heads, exhaust manifolds, transmission housings, water pumps and intake manifolds, bulk heads, wing spars, engine housings and components, hydraulic valve bodies, machine components, housings, gears and castings



Brush Diameter	Fill Diameter	Grit Size	Max RPM	Trim Length	Item Number
Silicon Carbide					
2-1/2	0.040	80	5,000	1	0003214600

ATB™ End Brushes

ATB™ End Brush

Small diameter brush featuring high-performing abrasive nylon filament to quickly and efficiently clean and finish inside diameters, spot facing, and recessed areas. Precision design makes these brushes ideal for operations where balance is critical, as in CNC and robotic use. Attached 1/4" stem also allows for use on portable air and electric tools.



Brush Diameter	Fill Diameter	Grit Size	Max RPM	Trim Length	Item Number
Silicon Carbide					
1/2	0.022	320	9,000	1	0003028700
1/2	0.024	120	9,000	1	0003028500
1	0.022	320	9,000	1	0003029500
1	0.024	120	9,000	1	0003029300

ATB™ End Brush w/ Bridle

The industry-best quality and performance of an Osborn ATB™ End Brush combined with a removable plastic bridle offers increased rigidity and aggression. Bridle keeps premium nylon filaments with choice of Silicon Carbide (for cleaning and finishing) or Ceramic (for tough deburring applications) abrasive from flaring for increased aggression.



Brush Diameter	Fill Diameter	Grit Size	Max RPM	Trim Length	Item Number
Ceramic					
3/8	0.026	120	9,000	1	0003087000
1/2	0.026	120	9,000	1	0003087200
3/4	0.043	120	9,000	1	0003087500
1	0.026	120	9,000	1	0003087600
1	0.043	120	9,000	1	0003087700
Silicon Carbide					
1/2	0.040	80	9,000	1	0003029600
1/2	0.040	120	9,000	1	0003029900
3/4	0.040	80	9,000	1	0003029700
3/4	0.040	120	9,000	1	0003030000
1	0.040	80	9,000	1	0003029800
1	0.040	120	9,000	1	0003030100



Safety First!

As a safety precaution, shank must be fully inserted into the chuck or collet and tightened securely.

ATB™ Internal Brushes

Ideal in both wet and dry applications, great for automated and manual operations. Premium quality ATB™ internal brushes are available in several filament styles allowing you to choose the right brush for your application.

ATB Helituf™ Internal Brush

Osborn ATB Helituf™ Internal Brushes are designed with high-quality nylon filament embedded with durable Silicon Carbide and unique helix design to provide efficient internal surface cleaning and deburring action. Helituf™ brushes should only be used with suitable holders and fully chucked.



Brush Diameter	Brush Area Length	Stem Diameter	Grit Size	Overall Length	Item Number
Silicon Carbide					
3/8	1	1/8	120	3-1/2	0003625000
3/8	1	1/8	120	3-1/2	0003625600
1/2	1	1/8	120	3-1/2	0003625100
1/2	1	1/8	120	3-1/2	0003625700
5/8	1	1/8	120	3-1/2	0003625200
5/8	1	1/8	120	3-1/2	0003625800
3/4	1	1/8	120	3-1/2	0003625300
3/4	1	1/8	120	3-1/2	0003625900
1	1	1/8	120	3-1/2	0003625400
1	1	1/8	120	3-1/2	0003626000
1-1/4	1	1/8	120	3-1/2	0003625500
1-1/4	1	1/8	120	3-1/2	0003626100

Use with Helituf extension holder 0007500300 features a 3/16" externally threaded stem, while extension holder 0007500400 features a 1/4" internally threaded stem. Use both extension holders together to form an 8" long brush.

ATB Situft™ Internal Brush

Osborn's ATB Situft™ Internal Brushes feature premium-quality abrasive nylon filaments to provide efficient, aggressive abrasive action across a wide range of internal cleaning and finishing operations. Situft™ brushes should be used only with suitable holders.

Applications: Cleaning threads, drilled holes and tubes where space is limited



Brush Diameter	Brush Area Length	Stem Diameter	Grit Size	Overall Length	Item Number
Silicon Carbide					
3/8	1	1/8	120	3-1/2	0003550000
1/2	1	1/8	120	3-1/2	0003550100
3/4	1	1/8	120	3-1/2	0003550300
1-1/4	1	1/8	120	3-1/2	0003550500

ATB™ Tube Brush

Featuring spiral-mounted nylon filaments with abrasive Silicon Carbide grit, Osborn ATB™ Tube Brushes offer extra cutting and cleaning action without sacrificing brush life. Brush can be mounted onto a portable or stationary tool for efficient operation.

Applications: Internal cleaning, removal of small imperfections, surface preparation



Brush Diameter	Brush Area Length	Stem Diameter	Grit Size	Overall Length	Item Number
Silicon Carbide					
3/8	2	0.187	80	5	0005601000
1/2	2	0.187	80	5	0005601100
5/8	2	0.208	80	5	0005601200
5/8	2	0.208	120	5	0005631200
3/4	2-1/2	0.238	80	5	0005601300
1	2-1/2	0.238	80	5-1/2	0005601500
1	2-1/2	0.208	120	5-1/2	0005631500
1-1/4	2-1/2	0.238	80	5-1/2	0005601600
1-1/4	2-1/2	0.238	120	5-1/2	0005631600

ATB™ Heavy Duty Internal Deburring Brush

Osborn ATB™ Heavy Duty Internal Deburring Brushes feature a higher filament content and are specifically designed to efficiently tackle the toughest tasks. Flexible crimped nylon filaments feature durable Silicon Carbide abrasive and are manufactured with a helical shape, providing optimal performance in both rotational directions with excellent part conformability.



Applications: Cross hole deburring, edge blending, edge radiusing, cam bores, crankcase bores, 2 stroke engines, valve bodies, pistons, cleaning threads, pipe IDs

Brush Diameter	Brush Area Length	Grit Size	Shank Diameter	Overall Length	Item Number
Silicon Carbide					
1	2	80	1/4	4-7/8	0003665000
1	2	120	1/4	4-7/8	0003665100
1-1/4	2	80	1/4	4-7/8	0003665200
1-1/2	2-1/2	120	3/8	6-1/4	0003665500
1-3/4	3	80	3/8	6-1/4	0003665600
2	3	80	3/8	6-1/4	0003665800
2-1/4	3	80	3/8	6-1/4	0003666000
2-1/4	3	120	3/8	6-1/4	0003666100
2-1/2	5	80	3/8	7	0003665400
2-1/2	3	80	3/8	6-1/4	0003666200
3	3	80	1/2	9	0003666400
3	3	120	3/8	6-1/4	0003665900
3	3	120	1/2	9	0003666500
3-1/2	3	80	1/2	9	0003666600
4	4	80	1/2	9	0003666800
4	4	120	1/2	9	0003666900

ATB™ Rectangular Filament Internal Brush

Featuring rectangular nylon strips impregnated with tough Aluminum Oxide, Osborn's ATB™ Rectangular Filament Internal Brush provides a highly efficient side-sweeping action across the surface. Filament shape applies approximately 18 times more abrasive contact than traditional round filaments. Aluminum Oxide ensures a superior finish and prolonged brush life.



Applications: Deburring and ID work on cylinders, camshaft bores, and valve bodies

Brush Diameter	Brush Area Length	Fill Diameter	Grit Size	Shank Diameter	Overall Length	Item Number
Silicon Carbide						
1	2	0.030	320	1/4	3-5/8	0003639400
1-1/2	2-1/2	0.030	320	3/8	4-7/8	0003639600
2-1/4	3	0.030	320	3/8	6-1/2	0003639900
2-1/2	3	0.030	320	3/8	6-1/2	0003640000
Aluminum Oxide						
1	7/8	0.045	120	1/8	3-5/8	0003630200
1	7/8	0.045	320	1/8	3-5/8	0003630300
1-1/2	2	0.045	120	1/4	4-7/8	0003630400
2-1/2	3-1/2	0.045	120	3/8	6-1/2	0003630800
3	4	0.045	120	3/8	6-1/4	0003631000
3	4	0.045	320	3/8	6-1/4	0003631100
3-1/2	4	0.045	120	3/8	6-5/8	0003631200
3-1/2	4	0.045	120	3/8	6-5/8	0003635800
4	4	0.045	120	3/8	6-3/4	0003631400
4	4	0.045	320	3/8	6-3/4	0003631500
4-1/2	4	0.045	120	3/8	6-1/2	0003631600
4-1/2	4	0.045	120	3/8	6-1/2	0003636200
4-1/2	4	0.045	320	3/8	6-1/2	0003631700
5	4	0.045	120	3/8	9-3/4	0003636400
5-1/2	4	0.045	120	3/8	10	0003636600
7	4	0.045	120	3/8	9-1/4	0003637000
7	4	0.045	320	3/8	9-1/4	0003637100

ATB™

ATB™ Microabrasive Internal Brushes

Designed for ultra-fine deburring and cleaning of holes produced by micro drilling, but will not alter the diameter or surface finish. On power tools, these brushes use a side-swiping action. They can also be used manually.

ATB™ Microabrasive Internal Brush



Premium high-performance nylon filaments with choice of embedded abrasives offer ultra-fine deburring and cleaning of holes produced by micro drilling. Designed for uniform brushing action that will not alter the hole diameter or surface finish. Can be used manually or on power tools. Constructed for longevity and use on applications requiring absolute precision. Note: brush selected should be ~0.015 inches larger than hole.

Applications: Aircraft & aerospace, computer & electronics, medical equipment, hydraulic fittings

Brush Diameter	Brush Area Length	Stem Diameter	Grit Size	Overall Length	Item Number
Alumina Silicate					
0.030	1/2	0.014	1000	4	0005640000
0.050	1/2	0.023	1000	4	0005640300
0.075	3/4	0.035	1000	4	0005640600
0.090	3/4	0.043	1000	4	0005640900
0.105	1	0.046	1000	4	0005641200
0.125	1	0.067	1000	4	0005641500
0.135	1	0.067	1000	4	0005641800
Silicon Carbide					
0.075	3/4	0.035	500	4	0005640700
0.090	3/4	0.043	320	4-3/4	0005607300
0.090	3/4	0.043	500	4	0005641000
0.105	1	0.046	320	4	0005607400
0.105	1	0.046	500	4	0005641400
0.125	1	0.067	320	4	0005607500
0.125	1	0.067	500	4	0005641700
0.135	1	0.067	320	4	0005607600
0.135	1	0.067	500	4	0005641900
0.165	1	0.093	320	5	0005607700
0.165	1	0.093	500	5	0005642600
0.190	1	0.093	320	5	0005607800
0.190	1	0.093	500	5	0005642800
0.260	1	0.121	320	5	0005607900
0.260	1	0.121	500	5	0005643000
0.325	1	0.121	320	5	0005608000
0.325	1	0.121	500	5	0005643300
0.385	1	0.154	320	5	0005608100
0.385	1	0.154	500	5	0005643700
0.515	1	0.175	320	5	0005608200
0.515	1	0.175	500	5	0005643900
0.640	1	0.175	320	5	0005608300
0.640	1	0.175	500	5	0005644200
0.765	1	0.228	320	5	0005608400
0.765	1	0.228	500	5	0005644600
0.890	1	0.228	320	5	0005608500
0.890	1	0.228	500	5	0005644800
1.015	1	0.255	320	5	0005608600

Continued on next page

ATB™ Microabrasive Internal Brush *Continued*



Brush Diameter	Brush Area Length	Stem Diameter	Grit Size	Overall Length	Item Number
Aluminum Oxide					
0.165	1	0.093	600	5	0005642500
0.190	1	0.093	600	5	0005642700
0.260	1	0.121	600	5	0005642900
0.325	1	0.121	600	5	0005643200
0.385	1	0.154	600	5	0005643500
0.515	1	0.175	600	5	0005643800
0.640	1	0.175	600	5	0005644100
0.765	1	0.228	600	5	0005644400
0.890	1	0.228	600	5	0005644700
1.015	1	0.255	600	5	0005645000



ATB™ Miniature Brushes

Osborn Precision Miniature Nylon Abrasive Brush Tools are designed for ultra-fine deburring, edge contouring, surface conditioning, cleaning and polishing. Can be used on extremely hard materials.

ATB™ Miniature End Brush

Osborn ATB™ Miniature End Brushes feature a small diameter for light duty cleaning, deburring, and surface finishing tasks. Brushes are constructed with premium nylon filaments with choice of Aluminum Oxide or Alumina Silicate abrasive.



Brush Diameter	Stem Diameter	Grit Size	Max RPM	Overall Length	Item Number
Alumina Silicate					
0.187	1/8	600	6,000	1-7/8	0007569200
0.25	1/8	1000	6,000	2-1/8	0007568600
Aluminum Oxide					
0.187	1/8	600	6,000	1-7/8	0007569300
0.25	1/8	600	6,000	2-1/8	0007568700
0.312	1/8	600	6,000	2-1/8	0007569800

ATB™ Miniature Cup Brush

Featuring flared nylon filaments with choice of embedded abrasive, Osborn's ATB™ Miniature Cup Brushes offer exceptional surface conditioning, cleaning, and polishing. Cup brush designs provide uniform performance over wider areas.



Brush Diameter	Stem Diameter	Grit Size	Max RPM	Overall Length	Item Number
Aluminum Oxide					
0.563	1/8	600	6,000	2-1/8	0007570700
Alumina Silicate					
0.563	1/8	1000	6,000	2-1/8	0007570600

ATB™ Miniature Wheel Brush

Versatile Osborn ATB™ Miniature Wheel Brushes are designed for uniform performance even when used on extremely hard materials. Each nylon filament is impregnated with choice of tough abrasive for precision ultra-fine deburring and edge contouring.



Brush Diameter	Stem Diameter	Grit Size	Max RPM	Overall Length	Item Number
Aluminum Oxide					
0.75	1/8	600	6,000	1-5/8	0007575200
1	1/8	600	6,000	1-5/8	0007576600
1.25	1/8	600	6,000	1-5/8	0007577000
1.5	1/8	600	6,000	1-5/8	0007577400
Alumina Silicate					
0.75	1/8	1000	6,000	1-5/8	0007575100
1	1/8	1000	6,000	1-5/8	0007576500

ATB™ NovoFlex Honing Tools

NovoFlex Flexible Honing Tools have round, abrasive beads fastened to the ends of flexible filaments. This self-centering tool will conform to the bore surface providing a consistent, even surface finish over the life of the tool. The ATB™ NovoFlex Flexible Honing Tool will even provide an “edge break” not possible with conventional honing stones.

ATB™ NovoFlex Introduction and Technical Information

NovoFlex Flexible Honing Tools are available for hole diameters ranging from 6.4mm to 203mm. Grit is available in Silicon Carbide & Aluminum Oxide in sizes from 60 to 320 for your application. These brushes are ideal for reaching into holes and crevices where other brushes cannot.

Great On:

- Engine bores
- Pneumatic and hydraulic bores
- Valve and pump housings
- Pipes
- Connecting rods
- Cam bores
- Crank bores
- Valve bores
- Hydraulic cylinders
- Stainless steel tubing

Applications:

- Honing
- Creating cross hatched surface pattern for oil retention
- Cylinder port area deburring
- Eliminating inside flashing



Instructions:

1. Choose the NovoFlex Flexible Honing Tool for the specific hole size. The actual NovoFlex Tool will be approximately 10% larger than the hole size.
2. Use 10–30 weight oil for honing lubrication, when honing hydraulic brake cylinders, use hydraulic brake fluid as a honing lubricant.
3. Have the NovoFlex Flexible Honing Tool rotating upon entry and removal from the bore.
4. Recommended RPM range for the NovoFlex Tool is 100 to 1200 RPM, based on the brush diameter. Air tools are not recommended.
5. Use 60–120 strokes per minute depending on the RPM. Final stroking may be accelerated to develop a 45 degree cross-hatch angle.
6. Honing time should be approximately 20/45 seconds per bore.
7. Do not use solvents for honing or cleaning.
8. Clean cylinders after honing with warm or hot water and detergent using an Osborn plain nylon brush, and then lightly oil the bore.

Novoflex–Small Diameter

Osborn's small diameter ATB™ Novoflex Tools are designed with round, abrasive beads fastened to the end of flexible nylon filaments sized to address smaller applications such as brake cylinders, hydraulics and valve guides. This self-centering tool will conform to the bore surface to provide a consistent, even surface finish over the life of the tool.



Inches	Used for Hole Diameter (mm)	Brush Length (mm)	Overall Length (mm)	Stem Diameter	120SC Part No.	180SC Part No.	240SC Part No.
0.196	5	50	200	0.072	—	0007728700	—
0.250	6.4	50	200	0.072	0007724600	0007724800	0007725000
0.276	7	50	200	0.072	0007724700	0007724900	0007725100
0.315	8	50	200	0.080	0007720000	0007722300	0007725200
0.354	9	50	200	0.080	0007720100	0007722400	0007725300
0.375	9.5	55	200	0.080	0007735900	0007736000	0007736100
0.394	10	60	200	0.080	0007720200	0007722500	0007725500
0.433	11	60	200	0.080	0007720300	0007722600	0007725600
0.472	12	60	200	0.091	0007736200	0007736300	0007736400
0.500	12.7	60	200	0.091	0007720400	0007722700	0007725800
0.512	13	60	200	0.105	0007720500	0007722800	0007737700
0.552	14	60	200	0.105	0007720600	0007722900	0007725900
0.630	16	60	200	0.105	0007720700	0007723000	0007726000
0.709	18.0	60	200	0.091	0007720800	0007723100	0007726100
0.750	19	70	200	0.105	0007720900	0007723200	0007726200
0.787	20	70	200	0.105	0007736500	0007736600	0007736700
0.875	22	70	200	0.105	0007721000	0007723300	0007726400
0.940	23.8	70	200	0.105	0007721100	0007723400	0007726500
1.000	25.4	70	200	0.105	0007721200	0007723500	0007726600
1.060	26.9	70	200	0.105	0007721300	0007723600	0007725700
1.125	29	70	200	0.105	0007721400	0007723700	0007726700
1.250	31.8	70	200	0.105	0007721500	0007723800	0007726800
1.375	35	70	200	0.105	0007721600	0007723900	0007726900
1.500	38	70	200	0.135	0007721700	0007724000	0007727000
1.625	41	70	200	0.135	0007721800	0007724100	0007727100
1.750	45	70	200	0.135	0007736800	0007736900	0007737000
2.000	51	70	200	0.135	0007737100	0007737200	0007737300
2.125	54	70	200	0.135	0007722000	0007724300	0007727400
2.250	57	70	200	0.135	0007722100	0007724400	0007727500
2.375	60	70	200	0.135	0007722200	0007724500	0007727600
2.500	64	70	200	0.135	0007737400	0007737500	0007737600

Novoflex–Standard Duty

Achieve a smooth, even surface finish with standard duty Osborn ATB™ Novoflex Tools. Tool is constructed of flexible nylon filaments that each have an abrasive bead fastened to the end of it. This tool is self-centering and is designed to conform to the bore surface for consistent finish and longevity.



Used for Hole Diameter (mm)	Brush Diameter	Brush Length (mm)	Overall Length (mm)	Stem Diameter	120SC Part No.	180SC Part No.	240SC Part No.
67	2.625	76	200	0.105	—	0007730000	0007727800
70	2.750	76	200	0.105	0007729700	0007730100	0007727900
73	2.875	76	200	0.105	0007729800	0007730200	0007728000
76	3.000	76	200	0.105	0007729900	0007730300	0007728100
83	3.250	76	343	0.300	0007737900	0007738000	0007738100
89	3.500	76	343	0.300	0007730500	0007730700	0007728300
95	3.750	89	343	0.300	0007730800	0007732500	0007734200
105	4.125	102	343	0.300	0007730900	0007732600	0007734300
118	4.625	114	343	0.300	—	0007732700	0007734400

Novoflex–Heavy Duty

The longer brush length of Osborn’s heavy duty ATB™ Novoflex Tool tackles tough honing projects with efficiency. Silicon Carbide abrasive beads are fastened to durable nylon filaments to allow the tool to conform to the bore surface. Flexible filaments are engineered to provide the correct pressure to create an ideal hone over the life of the tool.



Hole Diameter (mm)	Hole Diameter (in)	Brush Length (mm)	Overall Length (mm)	Stem Diameter	120SC Part No.	180SC Part No.	240SC Part No.
76	3.000	140	343	0.300	0007731100	0007732800	0007734500
83	3.250	140	343	0.300	0007731200	0007732900	0007734600
89	3.500	140	343	0.300	0007731300	0007733000	0007734700
95	3.750	140	343	0.300	0007731400	0007733100	0007734800
101	4.000	165	343	0.350	0007731500	0007733200	0007734900
108	4.250	165	343	0.350	0007731600	0007733300	0007735000
114	4.500	165	343	0.350	0007731700	0007733400	0007735100
127	5.000	165	457	0.350	0007731800	0007733500	0007735200
140	5.500	165	457	0.375	0007731900	0007733600	0007735300
152	6.000	165	457	0.375	0007732000	0007733700	0007735400
165	6.500	165	457	0.375	0007732100	0007733800	0007735500
178	7.000	178	457	0.375	0007732200	0007733900	0007735600
190	7.500	178	457	0.375	0007732300	0007734000	0007735700
203	8.000	178	457	0.375	0007732400	0007734100	0007735800



ATB™

ATB™ Softool Brushes

Smoother, Cleaner, Improved Performance

Looking for a honing finish that is smoother, cleaner and does not require a lengthy break-in period? You need Osborn Softool with flexible ATB™ abrasive nylon filaments that remove excess material left on the surface of the bore after honing with conventional methods.

Consistent Results

The performance of the Softool will remain consistent throughout its life as new grit is revealed through the wear of the brush, constantly exposing a gentle yet effective cutting surface.

Using Softool after honing with conventional abrasives or metal diamond stones will improve your finish by:

- Reducing peak height to decrease ring break-in period.
- Improving crosshatch for optimum oil retention and overall reduced oil consumption.
- Eliminating debris and contaminants from valleys allowing the rings to seat almost immediately.

Softool honing inserts and internal brushes will effectively improve your finish without changing the geometry or size of the bore!

Why is Softool so effective?

Softool has abrasive grit embedded into the flexible filaments. This flexibility allows the abrasive grit to cut without requiring high pressure that tears up the surface of the bore like conventional honing methods.

See the Difference!

See the difference when washing out the bore with hot, soapy water after honing. Debris that once decreased oil efficiency and wore on the ring will be knocked loose by Softool brush honing and washed away!

The surface profile of a cylinder bore honed with a metal bond diamond product (pic. 1), and the same bore after being brush honed with Osborn Softool brushes (pic. 2).

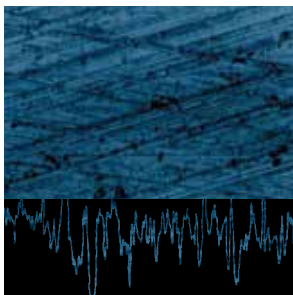

Pic. 1

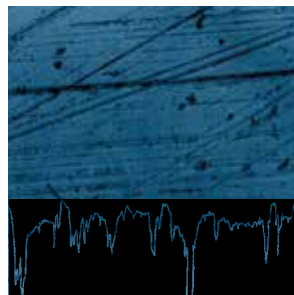

Pic. 2



ATB™ PCD Superabrasive

Fast, clean and consistent. Osborn ATB™ Diamond Superabrasives are engineered for today's superhard materials such as CBN and ceramics. ATB™ Superabrasives are made with polycrystalline diamond (PCD) impregnated filaments. Superior honing and polishing results can be achieved without the use of diamond paste or slurry.

PCD Superabrasive Introduction and Technical Information

A more efficient production environment. Without the need for diamond paste, ATB™ Diamond Superabrasives minimize or eliminate the secondary clean up operation. Osborn Superabrasives produce fast, consistent and repeatable honing results, lowering process cost and creating a cleaner, more efficient production environment.

Cutting tool insert before (left) and after (right) planetary honing operation with ATB™ PCD disc. ATB™ Superabrasive wheel brushes are easily adaptable to both common shop equipment as well as highly specialized machines. These tools can be used for a variety of polishing, deburring, and edge radiusing applications. Wheel brush tools are ideal for focused area work such as drill honing, polishing and indexable insert honing. ATB™ Superabrasives are capable of producing an edge radius of 0.0005"–0.003" on extremely hard materials such as CBN and ceramics. The degree of hone can be optimized by balancing PCD grain size, brush operating speed and cycle time. Grit sizes include 120, 240, 400, 600, and 1000 grit.

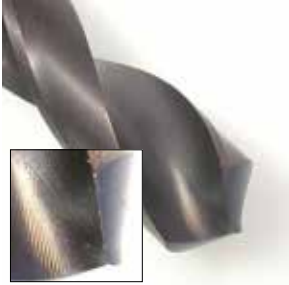

Before Honing

During Honing

After Honing



ATB™ Diamond Superabrasive Wheel Brush

Designed to provide uniform, repeatable results, Osborn ATB™ Diamond Superabrasive Wheel Brushes offer superior performance for a variety of polishing, deburring, and edge honing applications. Brushes are engineered for optimal edge honing of super hard materials such as CBN, ceramics, diamond, and glass without sacrificing brush life. ATB™ Diamond Superabrasives lower process costs and create a cleaner, more efficient production environment by minimizing or eliminating the secondary cleanup operation.



Brush Diameter	Grit Size	Arbor Hole Diameter	Max RPM	Trim Length	Face Width	Item Number
PCD						
6	400	1-1/4	6,000	1	1/4	0004100200
6	600	1-1/4	6,000	1	1/4	0004100100
6	1000	1-1/4	6,000	1	1/4	0004100000
8	400	1-1/4	6,000	1	1/4	0004101200



Adapters

Slip Fit	126
Threaded	126
Bushings	127
Arbor Drive	127
CNC	127

Metal Adapters For Brushes With 2" Arbor Hole

For use with Osborn wheel brushes. Slip fit adapter.

Adapter Fits Arbor Hole	Arbor Hole	Part No.
2	1/4	0007501900
2	3/8	0007502000
2	1/2	0007502100
2	5/8	0007502200
2	3/4	0007502300
2	7/8	0007502400
2	1	0007502500
2	1-1/8	0007502600
2	1-1/4	0007502700
2	1-1/2	0007502800



Metal Adapters for Wide Face Style Brushes with 2" Arbor Hole

Adapter Fits Arbor Hole	Arbor Hole	Part No.
2	5/8	0007503800
2	3/4	0007503900
2	1	0007504000
2	1-1/4	0007504100
2	1-1/2	0007504300
2	1-5/8	0007504400



Metal Adapters For Brushes With 1-1/4" Arbor Hole

For use with Osborn wheel brushes. Slip fit adapter.

Adapter Fits Arbor Hole	Arbor Hole	Part No.
1-1/4	1/4	0007504600
1-1/4	1/2	0007504800
1-1/4	5/8	0007504900
1-1/4	3/4	0007505000
1-1/4	1	0007505200



High Speed Thread Adapters

For use with small grinder brushes.

Adapter Fits Arbor Hole	Threaded Arbor Hole	Part No.
5/8-11NC	3/8-24UNF	0007518700
5/8-11NC	M10-1.25	0007518300
5/8-11NC	M10-1.50	0007518500



Centering Bushings For Small ID Brushes

Adapter Fits Arbor Hole	Threaded Arbor Hole	Part No.
1/2	1/4	0007505910
1/2	3/8	0007506010
5/8	1/4	0007506310
5/8	3/8	0007506210
5/8	1/2	0007506110



Brush Drive Arbors

For brushes up to 3" in diameter only. Designed for use with a single brush only. Not for use with grinding wheels, abrasive discs, buffs, buffing pads, or other non-brush perishable tools.



Diameter	Overall Length	Shank Dia.	Part No.
1/4	1-1/2	3/16	0007500700
3/8	1-3/4	1/4	0007500800
1/2	1-3/4	1/4	0007500900
5/8	1-3/4	1/4	0007501000

CNC Adapters For ATB Brushes

Brush Diameter	Arbor Hole	Shank Diameter	Description	Part No.
3	5/8	3/4	Type V	0007511700
4	5/8	3/4	Type V	0007511800
6-9	2	3/4	Type III	0007507700
6-14	2	1-1/4	Type III	0007508000

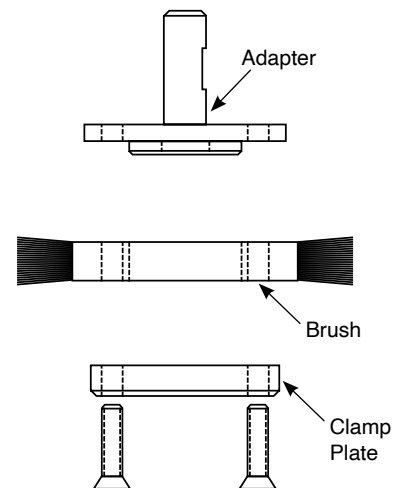



Maintenance

Maintenance Introduction	128
Floor Brooms	130–135
Counter Dusters	136–137
Utility Brushes	138–140
Scrub Brushes	141–142
Scratch Brushes	143–148

Maintenance Introduction

Osborn offers a complete line of top grade janitorial products to fill every industrial janitorial need. Our cleaning tools are designed for fast, efficient and thorough cleaning, scrubbing and washing jobs.

Osborn has been manufacturing brooms and brushes since 1887. Our brushes are produced to the highest standards for proven reliability. From simple hand brushes to the virtually unbreakable Flexsweep push broom, Osborn engineers our maintenance products to perform in the most demanding environments.

Floor Brooms



Counter Dusters



Utility Brushes



Scrub Brushes



Scratch Brushes



Floor Brooms

Broom blocks are kiln-dried, top quality hardwood, coated with a clear moisture-resistant sealer for long life and resistance to oil and chemicals. Fill materials are carefully selected grades of horsehair, natural fibers, synthetics and wire, as well as a wide range of mixtures. Fill materials are what make the difference with Osborn maintenance brushes.

Floor Brooms

Natural Fill Materials

Horsehair Long-lasting horsehair fiber, suitable for fine, light-duty sweeping only.

Tampico Fiber that performs equally well on wet or dry surfaces in medium applications.

Bassine Prime oiled fiber, resistant to moisture, for heavy-duty use.

Palmyra Ideal for rough wet or dry sweeping in heavy-duty applications. Can be washed out.

Synthetic Fill Materials

Polypro Excellent for both wet and dry applications. Resistant to acids and caustics. Can be used in various sweeping applications.

Styrene Offers high resistance to most common solvents such as gasoline, kerosene, etc. Can be used in various sweeping applications.

Synthetic Horsehair Economical horsehair substitute that performs equally to natural fiber.

Durapalm Economical, synthetic palmyra substitute with improved characteristics over natural fiber.

Note: To reduce “setting” of the bristles, store floor brushes with no weight against the fill material. This will prolong brush life and help preserve effectiveness. Periodically repositioning the handle to the opposite side of the block will also increase brush life and improve efficiency.



Flexsweep Floor Broom

Designed with a unique compact brace design and choice of premium fill materials, Osborn FlexSweep Floor Brooms offer exceptional performance and prolonged brush life. Blocks are constructed from lacquered hardwood maple with attached handle for extra strength. Unlike full block brace designs, Osborn's compact brace allows broom to reach confined areas like corners and shelves. Brace is constructed of durable urethane to absorb shock from impact and allow broom to flex slightly, lessening fatigue and extending block life.



Block Length	Trim Length	Item Number
Black Horsehair		
18	3	0005230100
Gold Flagged Styrene		
24	3	0005230700
Black Tampico		
18	3	0005231100
24	3	0005231200
Medium Brown Styrene		
18	3	0005231600
24	3	0005231700
Coarse Brown Styrene		
18	3-1/4	0005232600
24	3-1/4	0005232700
Black Bassine		
18	3-7/8	0005233600
24	3-7/8	0005233700



Use with Osborn's specially designed Flexsweep handle, boasting unmatched durability and flexibility. Part number 0007700600

Osborn Pro Economy Floor Broom

Combining performance and value, Osborn Economy Brooms feature durable construction and materials and an affordable price point. Blocks have threaded holes for wood or fiberglass handles, and your choice of fill materials are staple-set for longer service life.



Fill Material	Block Length	Trim Length	Part No.
Fine			
Black Horsehair	18	2-3/4	0008128400
Black Horsehair	24	2-3/4	0008128500
Blue Flagged Polypro	18	2-3/4	0008120600
Blue Flagged Polypro	24	2-3/4	0008120700
Blue Flagged Polypro	30	2-3/4	0008120800
Blue Flagged Polypro	36	2-3/4	0008120900
Brown Synthetic Horsehair	18	2-3/4	0008120100
Brown Synthetic Horsehair	24	2-3/4	0008120200
Medium			
Black Polypro	18	2-3/4	0008122100
Black Polypro	24	2-3/4	0008122200
Black Polypro / Horsehair	18	2-3/4	0008123100
Black Polypro / Horsehair	30	2-3/4	0008123300
Black Polypro / Horsehair	36	2-3/4	0008123400
Black Tampico	18	2-3/4	0008121100
Black Tampico	24	2-3/4	0008121200
Black Tampico	30	2-3/4	0008121300
Black Tampico	36	2-3/4	0008121400
Black Tampico & Mix	18	2-3/4	0008122600
Black Tampico & Mix	24	2-3/4	0008122700
Light / Dark Blue Polypro Mix	18	2-3/4	0008121600
Light / Dark Blue Polypro Mix	24	2-3/4	0008121700
Medium Brown Styrene	18	2-3/4	0008128900
Medium Brown Styrene	24	2-3/4	0008129000



Use with Osborn's high quality hardwood handle with metal threads. Part number 0007701500

Continued on next page

Osborn Pro Economy Floor Broom *Continued*

Fill Material	Block Length	Trim Length	Part No.
Coarse			
Black Bassine	18	3-7/8	0008129900
Black Bassine	24	3-7/8	0008130000
Blue Polypro	18	2-3/4	0008123600
Blue Polypro	24	2-3/4	0008123700
Blue Polypro	36	2-3/4	0008123900
Brown Palmyra / Black Tampico	18	2-3/4	0008124600
Brown Palmyra / Black Tampico	24	2-3/4	0008124700
Brown Palmyra / Black Tampico	30	2-3/4	0008124800
Coarse Brown Styrene	18	3-1/4	0008129400
Coarse Brown Styrene	24	3-1/4	0008129500
Coarse Brown Styrene	30	3-1/4	0008129600
Red Tampico / Wire Mix	18	2-3/4	0008124100
Red Tampico / Wire Mix	24	2-3/4	0008124200
Garage			
Brown Palmyra	18	3-7/8	0008125100
Brown Palmyra	24	3-7/8	0008125200
Brown Palmyra	30	3-7/8	0008125300



Master Sweep Floor Broom

Designed with densely packed durable Red Palmyra, Osborn Master Sweep Floor Brooms are ideal for wet or dry use in parking lots, streets and loading docks. Premium construction allows brushes to stand up to heavy-duty applications without affecting brush life. Brushes use standard threaded handles that are compatible with other Osborn products.



Block Length	Trim Length	Item Number
Red Palmyra		
16-7/16	7-1/4	0005205300
16-7/16	6-1/4	0005205400

Economy Street Broom

Durable, economic street broom in choice of Palmyra or Polypro fill. For use with standard tapered handles.



Block Length	Block Width	Trim Length	Item Number
Red Palmyra			
16-7/16	3-1/2	6-1/4	0008126000
Brown Polypro			
16-7/16	3-1/2	5	0008126100
Safety Orange Polypro			
16-7/16	3-1/2	5	0008126200



Use with Osborn's high quality hardwood tapered handle. Part number 0007701700

Economy Floor Broom–Plastic Block

Combining quality and value, these durable plastic block floor brushes are available in choice of fine, medium, or coarse fill material to tackle a variety of jobs. Brooms are commonly used in food service applications.



Block Length	Trim Length	Item Number
Silver Flagged Polypro		
18	3	0008126400
24	3	0008126500
Safety Orange Polypro		
18	3-1/4	0008127400
24	3-1/4	0008127500
Dark Blue Polypro		
18	3	0008127900
24	3	0008128000



Use with Osborn's strong, lightweight fiberglass handle. A perfect match for plastic block floor brooms in food service applications. Part number 0007702000

Wire Broom

Constructed of premium grade steel wire for sweeping and scrubbing uneven and rough surfaces such as cement, stone, or street pavement. Also ideal for cleaning industrial ovens, brick, and concrete.



Row Count	Block Length	Block Width	Item Number
Steel			
6	12	2-3/8	0005206100



Use with Osborn's high quality hardwood tapered handle. Part number 0007701700

Upright Corn Broom

Durable all-purpose brooms feature premium quality corn blend construction to tackle cleanup tasks ranging from easy sweeping to heavy industrial cleanup.



Trim Length	Overall Length	Handle Length	Handle Diameter	Item Number
Corn/Grass Blend				
17	56	39	1-1/8	0007514600
14	53	39	15/16	0007514800
Corn/Rattan Blend				
17	56	39	1-1/8	0007514700

Strip Floor Broom

Efficient, cost-effective floor brooms are designed for prolonged use without causing user fatigue. These high-performance brushes feature a lightweight, rust-resistant frame with choice of bristles for fine to coarse sweeping.



Block Length	Trim Length	Item Number
Gray Crimped Synthetic		
18	3-3/8	0005211000
24	3-3/8	0005211100
Black Crimped Synthetic		
18	3-3/8	0005211400
24	3-3/8	0005211500
Red Tampico Mix/Palmyra		
18	3-3/8	0005211800
24	3-3/8	0005211900
Blue Flagged Synthetic		
24	3-3/8	0005212300



Strip floor broom handles are specially designed to provide a strong attachment to strip floor brooms. Part number 0007702500

Stiff Whisk Broom

Designed with heavy-duty black Bassine moisture resistant fiber for industrial and shipyard use. Oil primed fibers are held in place with a durable metal band and reinforced with heavy wire binding for maximum durability.



Trim Length	Overall Length	Item Number
Black Bassine		
6	9-1/2	0005600200

Corn Whisk Broom

Versatile corn fiber broom with metal cap is ideal for quick, light-duty tasks, such as whisking away lint, dust, and fine dirt.



Trim Length	Overall Length	Item Number
Corn		
9	10-1/2	0005600100
Corn/Grass Blend		
5-1/2	11	0007515000

Counter Dusters

Osborn's counter dusters feature kiln-dried, top quality hardwood blocks, coated with a clear moisture-resistant sealer for long life and resistance to oils and chemicals. Fill materials are firmly staple set. All have a hang-up hole in the handle end for convenient storing.

Fine Counter Duster

Ideal for light-duty applications, this brush features a kiln-dried hardwood block with firmly staple-set Horsehair fill. Handle has a hang-up hole for convenient storage.



Brush Area Length	Trim Length	Item Number
Black Horsehair		
8	2-1/2	0005400100
9	2-1/4	0005400300

Coarse Counter Duster

Tackle heavier material removal and general factory/store dusting with Osborn Coarse Counter Dusters. Brushes feature choice of fill materials firmly staple-set in premium sealed hardwood. Handles have a hang-up hole for convenient storing.



Brush Area Length	Trim Length	Item Number
Black Tampico		
9	2-7/8	0005400400
8	2-1/2	0005400500
8	2-1/2	0008100300
Polypro		
8	1-7/8	0005400600
Grey Tampico		
8	2	0005400700
Light Blue Polypro		
8	2-1/2	0008100400

Curved Counter Duster

Unique curved end design allows for efficient corner cleaning. Hardwood handle is coated with moisture-resistant sealer with staple-set Grey Tampico, making it ideal for both wet and dry applications. Hang-up hole in handle offers convenient storage.



Brush Area Length	Trim Length	Item Number
Grey Tampico		
10	2-1/2	0005400800

Utility Brushes

Our utility brushes feature staple set bristles with wood and plastic blocks. This product line offers many options for handles and block types to meet your needs.

Window Brush

Premium industrial window washing brushes feature non-scratching fill and two tapered holes for use with standard tapered. Recommended for general use applications.



Brush Area Length	Brush Area Width	Trim Length	Item Number
Pure Black Horsehair			
8	2-1/2	2-1/2	0005406100
White Tampico			
8	2-1/2	2-1/2	0005406200



Use with Osborn's high quality hardwood tapered handle. Part number 0007701700

Car Wash Brush

Heavily filled with durable fiber, staple-set into plastic block. Designed for rail and bus transportation companies. Includes two handle holes, one threaded and one tapered, for use with your choice of handle (part number 00077001500 threaded handle | part number 0007701700 tapered handle).



Brush Area Length	Brush Area Width	Trim Length	Item Number
Grey Fiber			
10	2-1/2	2-1/2	0005620000

Nail Brush

Small solid hardwood block with staple-set white Tampico for a wide variety of general purpose cleaning tasks, including parts, washers, upholstery, carpets, and vegetable cleaning. Also ideal for cleaning hands and nails at sink stations.



Brush Area Length	Brush Area Width	Row Count	Trim Length	Item Number
White Tampico				
3-3/4	1-11/16	7	5/8	0005407900

Long Handle Utility Brush

Premium quality tampico, tightly spiral wound on a long hardwood handle. Perfect for hard-to-reach applications.



Brush Diameter	Brush Area Length	Overall Length	Item Number
Tampico Fiber			
3-1/2	6-1/2	24	0005600700

Radiator Brush

Designed with natural Pure China Bristle and angled hardwood handle for use in confined, hard-to-reach areas.



Brush Area Width	Trim Length	Overall Length	Item Number
Pure China Bristle			
1	1-7/8	15-3/4	0007090000
2	1-7/8	16	0007090100
4	1-1/2	20-1/2	0007090200

Scrub Brushes

Osborn's scrub brushes are staple set bristles with wood and plastic blocks. This product line offers many options for handles and block types to meet your needs.

Utility Scrub Brush–Short Handle

Choice of oval-trimmed fill material staple-set into hardwood handle. Short handle offers controlled scrubbing action.



Brush Area Length	Brush Area Width	Trim Length	Overall Length	Item Number
Tan Polypro				
5	6-1/2	2	10	0005407100
Brown Palmyra				
5	6-1/2	2	10	0005407200
White Tampico				
5	6-1/2	2	10	0005407300

Utility Scrub Brush–Long Handle

Choice of oval-trimmed fill material staple-set into long hardwood handle for ease of use.



Brush Area Length	Brush Area Width	Trim Length	Overall Length	Item Number
Tan Polypro				
5	6-1/2	2	21-3/4	0005407400
White Tampico				
5	6-1/2	2	21-3/4	0005407500
Brown Palmyra				
5	6-1/2	2	21-3/4	0005407600

Deck Scrub Brush

Heavy duty Osborn deck brush with hardwood block and built-in squeegee.



Brush Area Length	Brush Area Width	Trim Length	Item Number
Brown Palmyra			
10	2-7/8	2	0005406700



Use with Osborn's high quality hardwood tapered handle. Part number 0007701700

Scratch Brushes

The blocks of all Osborn Scratch Brushes are kiln-dried hardwood for maximum tuft retention, even in severe applications. Skilled workmanship assures you of uniform distribution of fill materials and firmly anchored tufts. The wire fill used in Osborn Scratch Brushes provides outstanding cleaning ability and offers an extremely high degree of fatigue resistance. The high-quality, staple-set wire provides long effective brush life.

Plater's Fine Wire Scratch Brush

Constructed of solid hardwood with choice of fine wire fill ideal for many hand brushing jobs in the plating process and metal finishing tasks. Shoe handle has hang-hole for convenient brush storage.



Brush Area Length	Brush Area Width	Fill Diameter	Row Count	Trim Length	Overall Length	Item Number
Steel						
5-3/4	1-1/8	0.006	4x18	1	13-1/4	0005403500
Brass						
4-3/4	1-1/16	0.006	4x18	1	10	0005403800
5-3/4	1-1/8	0.006	4x18	1	13-1/4	0005403600
Stainless Steel						
5-3/4	1-1/8	0.006	4x18	1	13-1/4	0005403700

Plater's Wire Scratch Brush

This narrow profile scratch brush with hardwood block shoe handle is ideal for cleaning threads and files, as well as aide in rust, paint, and grease removal during surface preparation.



Brush Area Length	Brush Area Width	Fill Diameter	Row Count	Trim Length	Item Number
Steel					
5	5/16	0.012	1x16	3/4	0005403900
Stainless Steel					
5	5/16	0.012	1x16	3/4	0005404000

Plater's Fiber Brush

Featuring a blend of natural Tampico and Palmyra fibers and a hardwood block handle, Osborn's well-crafted Plater's Fiber Brush is ideal for medium to heavy duty wet or dry cleaning applications during the plating and metal finishing process.



Brush Area Length	Brush Area Width	Row Count	Trim Length	Overall Length	Item Number
Brown Palmyra/White Tampico					
4-13/16	1-5/8	6x17	1	11-5/8	0005404600

Plater's Shoe Handle Fiber Brush

Hardwood shoe handle with densely packed natural fiber offers quick, uniform brushing action during general cleaning tasks. Recommended for use in plating and metal finishing process work.



Brush Area Length	Brush Area Width	Row Count	Trim Length	Overall Length	Item Number
Tampico Mixture					
5-1/4	1-1/16	4x18	1	10	0005404700

V-Trim Shoe Handle Brush

Designed with V-trimmed steel wire for outstanding cleaning ability and fatigue resistance. Wire tufts are precision cut and firmly anchored to hardwood shoe handle to provide exceptional performance and prolonged brush life.



Brush Area Length	Brush Area Width	Fill Diameter	Row Count	Trim Length	Overall Length	Item Number
Stainless Steel						
5-1/4	1	0.012	4x16	1-1/8	9-3/4	0005410300
Steel						
5-1/4	1	0.014	4x16	1-1/8	9-3/4	0005410400

V-Trim Long Handle Scratch Brush

V-trimmed wire tufts provide unmatched cleaning ability and reduced user fatigue. Wire is staple-set onto a long hardwood handle to extend brush life.



Brush Area Length	Brush Area Width	Fill Diameter	Row Count	Trim Length	Overall Length	Item Number
Stainless Steel						
6	15/16	0.012	3x19	1-1/4	13-3/4	0005410500
Steel						
6	15/16	0.014	3x19	1-1/4	13-3/4	0005410600

V-Groove Long Handle Scratch Brush

Designed specifically for use in hard-to-reach areas requiring a narrow face. Wire tufts are firmly anchored to long hardwood handle. Premium construction ensures long service life.



Fill Diameter	Row Count	Block Width	Trim Length	Item Number
Steel				
0.014	3x14	1-1/8	1-1/2	0005438700
Stainless Steel				
0.012	3x14	1-1/8	1-1/2	0005438800

Curved Handle Scratch Brush

Handy and economical, these efficient brushes are ideal for a wide variety of cleaning and surface preparation tasks. Brushes feature comfortable curved handle with choice of wire fill.



Brush Area Length	Fill Diameter	Row Count	Block Width	Trim Length	Overall Length	Item Number
Steel						
6	0.014	3x19	31/32	1-1/8	13-11/16	0005401500
6	0.014	4x19	1-1/4	1-1/8	13-11/16	0005401600
6	0.012	3x19	31/32	1-1/8	13-11/16	0005403200
6	0.014	3x19	15/16	1-1/8	13-3/4	0008300100
6	0.014	4x19	1-1/8	1-1/8	13-11/16	0008310000
Stainless Steel						
6	0.012	3x19	31/32	1-1/8	13-11/16	0005401700
6	0.012	4x19	1-1/8	1-1/8	13-11/16	0008310100
Brass						
5-3/4	0.012	3x19	31/32	1-1/8	13-3/4	0008400400

Shoe Handle Wire Scratch Brush

Durable wire and hardwood constructed scratch brush at an inexpensive price point. Available in a variety of wire fill materials to efficiently clean and prepare surfaces.



Brush Area Length	Fill Diameter	Row Count	Block Width	Trim Length	Overall Length	Item Number
Steel						
5-1/4	0.014	4x16	1-1/8	1-1/8	10	0005401800
5-1/4	0.014	2x15	5/8	1-1/8	10	0005403300
5-1/4	0.014	4x16	1-1/16	1-1/8	10	0008300300
5-1/4	0.014	4x16	1-1/16	1-1/8	10	0008300500
Stainless Steel						
5-1/4	0.012	4x16	1-1/8	1-1/8	10	0005401900
5-1/4	0.012	4x16	1-1/16	1-1/8	10	0008300800
Phosphorous Bronze						
5-1/4	0.012	4x16	1-1/8	1-1/8	10	0005402000
Brass						
4-3/4	0.012	4x16	1-1/16	1-1/8	10	0008401000

Straight Handle Scratch Brush w/ Scraper

Well-made hardwood scratch brush with attached angled scraper removes stubborn debris and rust during surface cleaning and preparation. Staple-set wire ensures uniform performance and longevity.



Brush Area Length	Fill Diameter	Row Count	Block Width	Trim Length	Overall Length	Item Number
Steel						
5-1/2	0.014	4x11	1-1/2	1-5/8	11-3/8	0005402100

Small Cleaning Scratch Brush

Available in variety of fill materials with choice of angled or curved back, Osborn Small Cleaning Scratch Brushes effectively clean and prepare small surface areas. Fill is staple-set for prolonged brush life.



Brush Area Length	Fill Diameter	Row Count	Trim Length	Overall Length	Item Number
Tan Polypro					
1-7/16		3x7	7/16	7-3/4	0005401300
Brass					
1-7/16	0.006	3x7	7/16	7-3/4	0005401400
2-1/2	0.006	2x9	5/8	8-5/8	0005402300
Stainless Steel					
1-7/16	0.006	3x7	7/16	7-3/4	0005402200
2-1/2	0.006	2x9	5/8	8-5/8	0005403000
Polypro					
2-1/2		2x9	5/8	8-5/8	0005403100
Steel					
1-7/16	0.008	3x7	7/16	7-3/4	0005404800

Small Cleaning Scratch Brush–Laced Back

Designed specifically for heavy-duty cleaning tasks, this Osborn brush features uniform tufts of rugged steel wire that are staple set and reinforced for maximum performance in severe applications.



Brush Area Length	Fill Diameter	Row Count	Trim Length	Overall Length	Item Number
Stainless Steel Wire					
1-7/16	0.006	3x7	7/16	7-1/2	0005405000

Plastic Handle Scratch Brush

Economical plastic and wire fill scratch brushes offer reliable performance for cleaning and surface preparation.



Brush Area Length	Fill Diameter	Row Count	Item Number
Steel			
5-1/2	0.012	1	0005970100
Stainless Steel			
5-1/2	0.012	1	0005970200
Brass			
5-1/2	0.012	1	0005970300

Plastic Small Cleaning Scratch Brush

Effectively target clean small areas with this economical wire fill scratch brush. Durable molded plastic handle with hang hole comes in choice of wire or synthetic fill for use on various surfaces.



Brush Area Width	Fill Diameter	Trim Length	Overall Length	Item Number
Stainless Steel Wire				
3/8	0.006	7/16	7-1/4	0008311100
Brass				
3/8	0.006	7/16	7-1/4	0008311200
Tan Polypro				
3/8	0.012	7/16	7-1/4	0008311300

Straight Back Scratch Brush

Solid hardwood block with staple-set steel wire fill makes this brush ideal for cleaning large flat stone or brick surfaces.



Brush Area Length	Brush Area Width	Fill Diameter	Row Count	Trim Length	Item Number
Steel					
7-1/4	2-1/4	0.014	6x19	1-11/16	0005402800
7-1/4	2-1/4	0.014	6x19	1-5/8	0008300200

V-Trim Cleaning Scratch Brush

Precision cut V-trim wire fill effectively cleans hard-to-reach areas and tight corners. Wire fill is firmly anchored in kiln-dried hardwood to provide consistent performance over the life of the brush.



Brush Area Length	Brush Area Width	Fill Diameter	Row Count	Trim Length	Overall Length	Item Number
Brass						
1-1/2	7/16	0.006	3x7	1/2	7-7/8	0005410000
Stainless Steel						
1-1/2	7/16	0.006	3x7	1/2	7-7/8	0005410100
Steel						
1-1/2	7/16	0.008	3x7	1/2	7-7/8	0005410200

File Card

Constructed of rugged steel wire to make quick work of surface prep prior to soldering or cleaning debris from files.



Brush Area Length	Overall Length	Item Number
Steel		
3-3/4	8-1/4	0007511600



Paint Brushes

Selection Guide	150–152
Introduction	152
Paint Brushes	153–160

Paint Brush Selection Guide

Application	Description	Professional	Premium
Wall Brushes			
Latex Paint	Economy synthetic, plastic handle	Nylon/polyester blend wall brush, wood handle 7/8" thick	Nylon/polyester blend wall brush, wood handle 1" thick
	Economy synthetic, general purpose brush, plastic handle		
	Black polyester wall brush 1" & 7/8" thick		
Oil Paint		Pure black china bristle wall brush, wood handle 7/8" thick	Pure black china bristle wall brush, wood handle 1" thick
Paint/Maintenance Brushes			
Oil & Chip	Economy pure white bristle brush, wood handle		
	Economy pure white bristle brush, plastic handle		
General Paint	Economy synthetic, plastic handle		
	Economy synthetic general purpose brush, plastic handle		
Latex Paint	Economy synthetic, plastic handle	Black polyester, plastic handle	Nylon/polyester blend brush, plastic handle
	Economy synthetic general purpose brush, plastic handle		
Oil Paint/Varnish	Economy china bristle brush, plastic handle	Polyester/grey bristle brush, plastic bow handle	Pure white china bristle brush, plastic handle
		Polyester/grey bristle brush, plastic kaiser handle	Pure white china bristle brush, wood handle
Polyurethanes & Synthetic Coatings	Economy synthetic, plastic handle		
	Economy synthetic general purpose brush, plastic handle	Black polyester, plastic handle	

Paint Brush Selection Guide

Application	Description	Professional	Premium
Paint/Maintenance Brushes			
Epoxies & Glue	Economy pure white bristle brush, wood handle		
	Economy pure white bristle brush, plastic handle		
	Economy synthetic, plastic handle		
Sash Brushes			
Latex Paint		Pure white china bristle angular flat, plastic handle	Pure grey bristly round, plastic handle
		Black polyester heavy flat, plastic handle	Pure grey bristly oval, plastic handle
Oil Paint/Varnish		Pure white china bristle flat, plastic handle	Pure black china bristle, plastic handle
		Black polyester angular flat, plastic handle	Pure grey bristly round, plastic handle
			Pure grey bristly oval, plastic handle
Polyurethanes & Synthetic Coatings		Pure white china bristle flat, plastic handle	Pure black china bristle, plastic handle
		Black polyester angular flat, plastic handle	Pure grey bristly round, plastic handle
			Pure grey bristly oval, plastic handle

Paint Brushes

Osborn offers a complete line of paint brushes at quality levels trusted by facility maintenance and professional painters. The Osborn name guarantees quality, and carries completely dependable products that are built to give you maximum value and performance. Osborn paint tools are available with four main types of fill: China Bristle, Nylon/Polyester, Polyester, and Soft Hair.

China Bristle

Carefully selected for proper stiffness and taper, Chinese hog bristle is best suited for spreading oil-base paints, enamels, stains, shellacs and epoxy coatings.



Polyester

A durable synthetic filament that smoothly spreads latex and oil-base paints equally well. Retains stiffness and flexibility in extreme hot weather conditions. Gives fine service, easy to clean out.

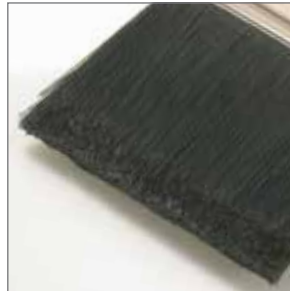

Soft Hair

Fine animal hair brushes are essential for laying on exceptionally smooth lacquer, shellac, varnish and enamel finishes.



Nylon/Polyester

Multi-polyester and nylon filament tips provide extra wear and will give excellent service with all paints. All filaments are flagged and tipped for excellent paint pick-up and smooth application.



Pure White China Bristle

Premium white china bristle is best suited for spreading oil-base products such as paint, enamel, shellac and epoxy coating. Available with plastic or wood beaver tail handle.



Overall Width	Trim Length	Paintbrush Thickness	Handle Material	Item Number
White China Bristle				
1/2	1-3/4	1/4	Plastic	0007006700
1	2-1/4	7/16	Plastic	0007006800
1-1/2	2-1/2	1/2	Plastic	0007006900
2	2-3/4	9/16	Plastic	0007007000
2-1/2	2-3/4	5/8	Plastic	0007007100
3	3	11/16	Plastic	0007007200
4	3-1/4	7/8	Plastic	0007007300
1/2	1-3/4	1/4	Wood	0007015000
1	2-1/4	7/16	Wood	0007015100
1-1/2	2-1/2	1/2	Wood	0007015200
2	2-3/4	9/16	Wood	0007015300
2-1/2	2-3/4	5/8	Wood	0007015400
3	3	11/16	Wood	0007015500
4	3-1/4	7/8	Wood	0007015600

Nylon/Polyester Blend Brush

Versatile synthetic blend brush ideal for use with all paints. Solid wood beaver tail handle.



Overall Width	Trim Length	Paintbrush Thickness	Handle Material	Item Number
Nylon/Polyester				
1	2-1/4	7/16	Plastic	0007105700
1-1/2	2-1/2	1/2	Plastic	0007105800
2	2-3/4	9/16	Plastic	0007105900
2-1/2	3	5/8	Plastic	0007106000
3	3-1/4	11/16	Plastic	0007106100
4	3-1/2	7/8	Plastic	0007106200

Polyester Grey Bristle Brush with Bow Handle

Ideal for use with oil paint and varnish. Plastic bow handle.



Overall Width	Trim Length	Paintbrush Thickness	Handle Material	Item Number
Mixed Polyester/Bristle				
1	2	3/8	Plastic	0007110000
1-1/2	2	7/16	Plastic	0007110100
2	2-1/4	7/16	Plastic	0007110200
3	2-1/2	1/2	Plastic	0007110400
4	2-3/4	11/16	Plastic	0007110500

Pure Grey Bristle Brush

Multi-use bristle brush with plastic Kaiser handle. Ideal for use as chip brush.



Overall Width	Trim Length	Paintbrush Thickness	Handle Material	Item Number
Grey Bristle				
1	2	3/8	Plastic	0007110600
1-1/2	2	3/8	Plastic	0007110700
2	2	7/16	Plastic	0007110800
2-1/2	2-1/4	1/2	Plastic	0007110900
3	2-1/4	1/2	Plastic	0007111000

Polyester Grey Bristle Brush with Kaiser Handle

Ideal for use with oil paint and varnish. Plastic Kaiser handle.



Overall Width	Trim Length	Paintbrush Thickness	Handle Material	Item Number
Mixed Polyester/Bristle				
1/2	1-11/16	1/4	Plastic	0008614400
1	2	3/8	Plastic	0008613300
1-1/2	2	7/16	Plastic	0008613400
2	2	1/2	Plastic	0008613500
3	2-1/4	1/2	Plastic	0008613600
4	2-1/2	11/16	Plastic	0008613700

Pure White China Bristle Flat Sash Tool Brush

Professional-grade white china bristle with plastic handle. Excellent for use with oil paint, varnish, polyurethanes and synthetic coatings.



Overall Width	Trim Length	Paintbrush Thickness	Handle Material	Item Number
China Bristle				
1	2-1/4	7/16	Plastic	0007008500
2	2-3/4	9/16	Plastic	0007008700

Black Polyester Brush

Small, versatile brush for use with latex and oil-base paints. Plastic beaver tail handle.



Overall Width	Trim Length	Paintbrush Thickness	Handle Material	Item Number
Polyester				
1	2-1/4	7/16	Plastic	0007202500
1-1/2	2-1/2	1/2	Plastic	0007202600
2	2-3/4	9/16	Plastic	0007202700

Economy Chip Brush

Affordable chip brush available in several varieties of fill with choice of wood or plastic handle.



Overall Width	Trim Length	Paintbrush Thickness	Handle Material	Item Number
Plastic Filament				
1	1-3/4	5/16	Wood	0007203000
2	1-3/4	7/16	Wood	0007203100
3	2	1/2	Wood	0007203200
Black Tampico Fiber				
1-1/2	1-7/8	11/16	Wood	0007303500
White Bristle				
1/2	1-1/2	1/4	Plastic	0008600100
1	1-1/2	5/16	Plastic	0008600200
1-1/2	1-1/2	5/16	Plastic	0008600300
2	1-1/2	5/16	Plastic	0008600400
2-1/2	1-1/2	3/8	Plastic	0008600500
3	1-1/2	3/8	Plastic	0008600600
4	2-1/4	11/16	Plastic	0008600700
1/2	1-1/2	1/4	Wood	0008601500
1	1-1/2	5/16	Wood	0008601600
1-1/2	1-1/2	5/16	Wood	0008601700
2	1-1/2	5/16	Wood	0008601800
2-1/2	1-1/2	3/8	Wood	0008601400
3	1-1/2	3/8	Wood	0008601900
4	2-1/4	11/16	Wood	0008602000

Pure White China Bristle Angular Sash Brush

Angled trim ideal for cutting into corners and edging. For use with oil paint, varnish, polyurethanes and synthetic coatings. Plastic handle.



Overall Width	Trim Length	Paintbrush Thickness	Handle Material	Item Number
China Bristle				
1-1/2	2-1/4	7/16	Plastic	0007008900
2	2-1/2	7/16	Plastic	0007009000

Black Polyester Angular Sash Brush

Durable synthetic filaments ideal for use with latex and oil-base paints. Angled trim makes quick work of edging and cutting into corners. Plastic handle.



Overall Width	Trim Length	Paintbrush Thickness	Handle Material	Item Number
Polyester				
2	2-1/2	7/16	Plastic	0007129000

Economy Black Polyester Paint Brush

An affordable, all-purpose brush with durable synthetic polyester fill. Plastic handle.



Overall Width	Trim Length	Paintbrush Thickness	Handle Material	Item Number
Polyester				
1/2	1-3/4	1/4	Plastic	0008602100
1	1-3/4	5/16	Plastic	0008602200
1-1/2	1-3/4	5/16	Plastic	0008602300
2	1-3/4	5/16	Plastic	0008602400
3	1-3/4	3/8	Plastic	0008602600
4	2-1/4	11/16	Plastic	0008602700

Economy Black Polyester General Purpose Brush

Economical general use brush with durable synthetic polyester fill and plastic handle.



Overall Width	Trim Length	Paintbrush Thickness	Handle Material	Item Number
Polyester				
1	2	3/8	Plastic	0008612800
1-1/2	2	7/16	Plastic	0008612900
2	2-1/4	7/16	Plastic	0008613000
3	2-1/4	1/2	Plastic	0008613100
4	2-3/4	11/16	Plastic	0008613200
4	3-1/2	7/8	Plastic	0008614300

Pure Black China Bristle Oval Sash Brush

Constructed with premium-quality black China bristle ideal for use with oil paints and varnishes. Wood handle.



Brush Number	Trim Length	Paintbrush Thickness	Handle Material	Item Number
China Bristle				
2	1-5/8	1/2	Wood	0007009100
4	1-7/8	3/4	Wood	0007009200
6	2-1/8	7/8	Wood	0007009300
8	2-3/8	1	Wood	0007009400
10	2-5/8	1-1/8	Wood	0007009500

Pure Grey China Bristle Round Sash Brush

Versatile round sash brush for use with oil-base products or as a chip brush. Plastic handle.



Brush Number	Trim Length	Paintbrush Thickness	Handle Material	Item Number
Grey China Bristle				
4	1-7/8	11/16	Plastic	0007111200
6	2-1/8	13/16	Plastic	0007111300
8	2-3/8	15/16	Plastic	0007111400
10	2-5/8	1-1/16	Plastic	0007111500

Pure Grey China Bristle Oval Sash Brush

Exceptional stiffness and taper for spreading oil-base paints, enamels, stains, shellacs and epoxy coatings. Premium grey China bristle fill with plastic handle.



Brush Number	Trim Length	Paintbrush Thickness	Handle Material	Item Number
Grey China Bristle				
2	1-5/8	1/2	Plastic	0007111600
4	1-7/8	3/4	Plastic	0007111700
6	2-1/8	7/8	Plastic	0007111800
8	2-3/8	1	Plastic	0007111900
10	2-5/8	1-1/8	Plastic	0007112000
12	2-7/8	1-5/16	Plastic	0007112100

Camel Hair Round Lettering Marking Brush

Flexible, natural hair fill with rounded trim. Wood handle.



Brush Number	Brush Diameter	Trim Length	Handle Material	Item Number
Camel Hair				
1	1/16	7/8	Wood	0007402000
2	5/64	7/8	Wood	0007402100
3	3/32	1	Wood	0007402200
4	7/64	1	Wood	0007402300
5	1/8	1	Wood	0007402400
6	5/32	1-1/16	Wood	0007402500
8	3/16	1-1/4	Wood	0007402700
12	1/4	1-1/2	Wood	0007402900

Pure Bristle Flat Artist's or Fitch Marking Brush

Chiseled edge natural bristle fill brush with walnut lacquered wood handle.



Overall Width	Trim Length	Handle Material	Item Number
Bristle			
1/4	1	Wood	0007010000
1/2	1-1/8	Wood	0007010100
3/4	1-3/8	Wood	0007010200
1	1-3/4	Wood	0007010300
1-1/2	2-3/8	Wood	0007010500

Red Sable Artist's Brush

Soft, round natural fill with tapered wood handle.



Brush Number	Brush Diameter	Trim Length	Handle Material	Item Number
Red Sable				
3/0	1/32	1/4	Wood	0007406500
2/0	3/64	5/16	Wood	0007406600
0	1/16	7/16	Wood	0007406700
1	5/64	1/2	Wood	0007406800
2	3/32	9/16	Wood	0007406900
4	1/8	5/8	Wood	0007407000
6	5/32	3/4	Wood	0007407100

Camel Hair Round Lettering Lacquering Brush

Flexible, natural fill with tapered wood handle.



Brush Number	Brush Diameter	Trim Length	Handle Material	Item Number
Camel Hair				
1	9/64	11/16	Wood	0007401000
2	13/64	13/16	Wood	0007401100
3	15/64	1	Wood	0007401200
4	9/32	1-1/16	Wood	0007401300
5	5/16	1-1/8	Wood	0007401400
6	11/32	1-3/16	Wood	0007401500

Pure China Bristle Stencil Marking Brush

Densely packed pure china bristle for use with oil-base paints and coatings. Wood handle.



Brush Number	Brush Diameter	Trim Length	Handle Material	Item Number
China Bristle				
4	1	1-1/4	Wood	0007010700
6	1-1/4	1-1/2	Wood	0007010800
8	1-1/2	1-5/8	Wood	0007010900

Camel Hair Round Marking Brush

Natural fill with tapered wood handle.



Brush Number	Brush Diameter	Trim Length	Handle Material	Item Number
Camel Hair				
1	9/64	5/8	Wood	0007400100
2	5/32	3/4	Wood	0007400200
3	3/16	7/8	Wood	0007400300
4	7/32	1	Wood	0007400400
5	1/4	1-1/16	Wood	0007400500
6	9/32	1-1/8	Wood	0007400600

Pure White Bristle Round Marking Brush

Economical white bristle brush with tapered wood handle.



Brush Number	Brush Diameter	Trim Length	Handle Material	Item Number
White Bristle				
1	9/64	11/16	Wood	0007403000
2	5/32	3/4	Wood	0007403100
3	3/16	7/8	Wood	0007403200
4	7/32	1	Wood	0007403300
5	1/4	1-1/16	Wood	0007403400
6	9/32	1-1/8	Wood	0007403500

Ox Hair Sign Writer's Brush

Premium natural bristle brush ideal for use with oil-base paints and stains. Wood handle.



Overall Width	Trim Length	Handle Material	Item Number
Ox Hair			
1/4	7/8	Wood	0007302000
1/2	1	Wood	0007302100
3/4	1-1/16	Wood	0007302200
1	1-1/8	Wood	0007302300
1-1/2	1-1/2	Wood	0007302400

Ox Hair One Stroke Brush

Highest-quality natural fill. Performs exceptionally with oil-base paints and stains. Wood handle.



Overall Width	Trim Length	Handle Material	Item Number
Ox Hair			
1/8	11/16	Wood	0007404000
1/4	13/16	Wood	0007404100
3/8	15/16	Wood	0007404200
1/2	1	Wood	0007404300
3/4	1-1/4	Wood	0007404400
1	1-1/2	Wood	0007404500

Foam Paintbrush

Economical foam brush with chiseled edge and wood handle.



Overall Width	Trim Length	Overall Length	Handle Material	Item Number
Foam				
1	2	6-1/8	Wood	0007037400
2	2-1/2	6-3/8	Wood	0007037500
3	2-1/2	6-1/2	Wood	0007037600
4	3	7-5/16	Wood	0007037700

Horsehair Tin Ferrule Acid Brush

Ideal for use with acid, lubricant, and glue. Tin ferrule design prevents bristles from loosening for longevity.



Overall Width	Trim Length	Overall Length	Handle Material	Item Number
Horse Hair				
1/4	39/64	6	Tin	0007405900
3/8	3/4	6-1/8	Tin	0007406000
7/16	7/8	6-1/8	Tin	0007406100
9/16	7/8	6-1/8	Tin	0007406200

Parts Cleaning Brush

Handy tool for cleaning motor parts and more. Available with choice of fill. Wood or plastic handle.



Brush Number	Brush Diameter	Trim Length	Handle Material	Item Number
Pure China Bristle				
1-1/2	1-1/2	2-3/8	Wood	0007011500
Pure Grey Bristle				
10	15/16	2-7/8	Plastic	0007113500
10	1-1/16	2-7/8	Plastic	0007113600
Grey Tampico				
8	15/16	2-7/8	Wood	0007302700
8	1-1/16	2-7/8	Wood	0007302800

Economy Crimped Polyester Parts Cleaning Brush

Economical polyester brush with crimped fill. Ideal for cleaning motors, machinery, and metal parts. Plastic handle.



Brush Diameter	Trim Length	Overall Length	Handle Material	Item Number
Polyester				
1-1/8	2-3/4	11	Plastic	0007597500



Polishing

General Information	162–164
Airway Buffs	165
Conventional Buffs	166
Non-Woven/ Convolute Wheels	167
Flap Brushes and Wheels	168

EXPECT MORE

**Yes.
We're as good at
polishing as we
are at brushes.**

At Osborn, Start to Finish isn't just a tagline, it's a promise. Our commitment to providing cost effective, results-based metal finishing solutions extends far beyond the brushes you know and trust for your business. We are a leader in polishing solutions, combining our resources and experts to both solve your toughest finishing challenges while identifying cost savings within the process.



Industries

At Osborn, we recognize your challenges are complex and diverse. We have the experience and expertise to provide the proper solution for your specific requirements in a large variety of industries and applications.

We listen and then collaborate.

We solve polishing problems ranging from aluminum wheels and cookware to musical instruments and automotive. The combination of experience and commitment to quality is second-to-none and allows us to serve our customers with the right solution for the job while guaranteeing the expected quality levels.

Why Polishing Solutions?

Osborn is fully committed to offering the best and most complete buff and polish solutions for any surface treatment or application.



Industry Expertise

Our 1,250 experts have accumulated decades of experience in a wide variety of markets. We listen and collaborate to improve your processes, find cost savings, increase productivity and find the best solution for your toughest application challenges.

Most Complete Portfolio in the Industry

Our unique combination of expertise and commitment to quality gives us an edge, as well as the ability to provide our customers the broadest offering in the industry. Period.

Innovative and Tailored Solutions

We are focused on offering our customers customized solutions to achieve the highest quality surface finishing results. Our experts will provide you with innovative, tailored product and process solutions to achieve your desired final look.

Buffing

Osborn buff and compound products provide practical solutions for product finishing. Every buff is constructed from the very best quality materials, carefully woven full-weight material, tightly sewn with premium thread for accurate, even balancing. Osborn products are designed for performance and longevity, ultimately reducing your manufacturing finishing costs.

Airway Buffs



Airway Cloth

Osborn Airway Buffs are a general purpose buff for both hand and automatic buffing. These quality buffs are effective finishing tools for ferrous and non-ferrous metals, marble, plastics and other materials. Ideal for both cut and color buffing.



Airway Pleated Buff

Osborn Airway Pleated Buffs are constructed of premium quality cloth and ideal for use in tangential, contour and mush buffing. This popular buff can be modified in a variety of ways, including dip treatments, to provide a customized finishing solution for your specific task.



Airway Finger Buff

Offered with choice of all cloth or cloth and sisal, Osborn Airway Finger Buffs offer versatility when tackling irregular shapes. Buffs can be dip treated for added flexibility and cutting capabilities. Ideal for applications including automotive bumpers and cookware.



Open Double Cloth Bias Sisal (ODCBS)

Constructed with alternating layers of sisal and cotton, Osborn Double Cloth Bias Sisal Buffs are ideal for tasks where a fast cut and soft finish are desired. Primarily designed for flat or contoured surfaces of ferrous and non-ferrous parts.

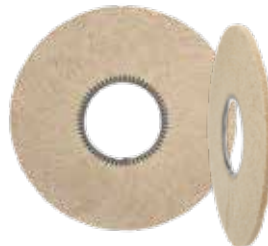

Bias Sisal

Osborn Airway Sisal Buffs are constructed using 100% sisal and sewn to specification. These buffs provide a highly aggressive cut, ideal for use on steel and stainless steel. Dip treatment can be specified to alter the flexibility and cutting capability of each buff.

CONVENTIONAL BUFF SOLUTIONS



Conventional Buffs

Osborn Conventional buffs are suited for cut and color applications. They also excel as a flexible platform for satin finishing. All conventional buffs are made with 1" arbor hole.



Concentric or Spiral Sewn Conventional Buff

Osborn Spiral and Concentric Sewn Conventional Buffs feature a harder, less flexible construction ideal for cut buffing parts and metal components, hard rubber and plastics with flat or accessible surfaces.



Loose Conventional Buff

This soft, flexible buff is ideal for color buffing and reaching uneven surfaces.



For even better performance, use Osborn buffs with our compound solutions. These compounds are made of tightly-sized abrasives held together with binders. Different kinds of abrasives are used for finishing various materials. Buffing compounds are made for the two phases of buffing: "cutting down" and "coloring." Available in bars and liquid.

NON-WOVEN AND CONVOLUTE WHEELS



Non-woven

Designed for exceptional performance on a range of materials, Osborn Non-woven products offer superior finishing of uniform surfaces. Available in a variety of sizes and styles. Our tailored solutions are ideal for tackling tough finishing, deburring, blending and polishing of steel, wood, plastic and more with ease. Non-woven products excel at blending deep scratches to match surrounding finishes, and are the ideal solution to improve and/or change the roughness of a surface.

Convolute Wheels

Convolute wheels feature abrasives for deburring, finishing, and polishing of metals or woods without breaking edges or removing material.

Light Osborn Light Deburring Wheels are designed with fine grit and medium density to remove light burrs and produce a fine, highly polished finish on a variety of surfaces.

General Deburring Osborn General Deburring Wheels offer exceptional deburring capabilities on a variety of metal, including stainless steel, titanium and other alloys. Suited for a wide range of deburring requirements on a variety of metals such as stainless steel, titanium and other alloys.

FLAP BRUSHES AND FLAT WHEELS



Flap Brushes–Non-woven Abrasives

Spin-on Designed with coarse and medium grit and hard density, Osborn Spin-on Finishing Flap Brushes are the ideal solution for blending and finishing stainless steels and other metals.

General Purpose

Osborn's general finishing flap brush offers consistent surface finishing with good conformability. Available in coarse medium and fine grit these brushes meet a vast number of required surface finishes on copper, brass, stainless steel, aluminum and other metals.

Flap Wheels

Osborn Flap Wheels are available a variety of styles with varying degrees of cutting ability and finish. They are constructed of abrasive and/or non-woven flaps radiating from a center hub. Flaps are attached to the hub and to each other using various materials and methods to ensure longevity.

Alpha Index

Product Name	Page	Product Name	Page	Product Name	Page
Airway Cloth Buff.....	165	ATB™ Rectangular Filament Internal Brush.....	113	Crimped Wire Cup Brush.....	36
Airway Finger Buff.....	165	ATB™ Tube Brush.....	112	Crimped Wire Cup Brush with Shank.....	37
Airway Pleated Buff.....	165	Bias Sisal Buff.....	165	Crimped Wire End Brush.....	47
ATB Fascut™ Wheel Brush– Aggressive.....	97	Black Polyester Angular Sash Brush.....	155	Crimped Wire End Brush– Scuf-Gard.....	48
ATB Fascut™ Wheel Brush– Flexible.....	98	Black Polyester Brush.....	154	Crimped Wire Medium Face Wheel Brush.....	18–19
ATB™ Heavy Duty Internal Deburring Brush.....	113	Brass Wire End Brush–Bridled....	53	Crimped Wire Narrow Face Wheel Brush.....	17–18
ATB Helituf™ Internal Brush.....	112	Brass Wire Tube Brush– Double Stem, Double Spiral.....	62	Crimped Wire Radial Section– Light Duty.....	17
ATB Master™ Wheel Brush.....	99	Brass Wire Tube Brush– Single Stem, Single Spiral.....	61	Crimped Wire Spiral Tube Brush–Single Stem, Single Spiral.....	60
ATB Monarch™ Wheel Brush.....	100	Brush Drive Arbors.....	127	Crimped Wire Tube Brush– Double Stem, Double Spiral.....	59
ATB Ringlock™ Brush.....	100	Camel Hair Round Lettering Lacquering Brush.....	158	Crimped Wire Tube Brush– Single Stem, Single Spiral.....	60
ATB Situft™ Internal Brush.....	112	Camel Hair Round Lettering Marking Brush.....	157	Crimped Wire Wheel Brush with Shank.....	16
ATB Uni-Lok® Bridle.....	106	Camel Hair Round Marking Brush.....	158	Crimped Wire Wide Face Wheel Brush.....	19
ATB Uni-Lok® Disc Brush Drive Arbor.....	106	Car Wash Brush.....	139	Curved Counter Duster.....	137
ATB Uni-Lok® Max Density Disc Brush.....	103	Cement Cleaning Brush.....	27	Curved Handle Scratch Brush..	145
ATB Uni-Lok® Quick Change Brush.....	105	Center Bushing for Small Arbor Hole.....	127	Cutoff Wheel–A.....	74
ATB Uni-Lok® Tufmatic Disc Brush.....	105	Circular Crimped Wire End Brush.....	48	Cutoff Wheel–A+.....	74
ATB Uni-Lok® Turbo Disc Brush.....	104	Circular Polypropylene Scrub Brush.....	44	Cutoff Wheel–EXT.....	74
ATB™ Cup Brush–Flat Trim.....	108	CNC Adapters for ATB™ Brushes.....	127	Deck Scrub Brush.....	142
ATB™ Cup Brush–Round Trim..	108	Coarse Counter Duster.....	137	Economy Black Polyester General Purpose Brush.....	156
ATB™ Cup Brush with Shank....	109	Concentric/Spiral Sewn Conventional Buff.....	166	Economy Black Polyester Paint Brush.....	156
ATB™ Diamond Superabrasive Wheel Brush.....	124	Conventional Buff.....	166	Economy Chip Brush.....	155
ATB™ End Brush.....	110	Convolute Wheels.....	167	Economy Crimped Polyester Parts Cleaning Brush.....	160
ATB™ End Brush w/ Bridle.....	110	Corn Whisk Broom.....	135	Economy Floor Broom– Plastic Block.....	134
ATB™ Microabrasive Internal Brush.....	114	Crimped High Speed Small Grinder Wire Wheel Brush.....	21	Economy Street Broom.....	133
ATB™ Miniature Cup Brush.....	116	Crimped Polypropylene Wheel Brush.....	33		

Alpha Index

Product Name	Page	Product Name	Page	Product Name	Page
File Card.....	148	Knot Wire Bridled Cup Brush.....	43	Non-Metallic End Brush-Bridled.....	53
Fine Counter Duster.....	137	Knot Wire Cup Brush.....	38	Non-woven Buff.....	167
Flap Brush– Non-Woven Abrasive.....	168	Knot Wire Cup Brush–Reduced Flare, Heavy Duty.....	39	Novoflex.....	119
Flap Disc–EXT.....	82	Knot Wire Cup Brush– Staggered Row.....	40	Novoflex–Heavy Duty.....	120
Flap Disc–Z.....	83	Knot Wire Cup Brush w/ Bridle– Heavy Duty.....	39	Novoflex–Small Diameter.....	119
Flap Wheel.....	168	Knot Wire End Brush.....	49	Nylon Percolator Brush.....	62
Flexsweep Floor Broom.....	132	Knot Wire End Brush– Scuf-Gard.....	50	Nylon Tube/Spout Brush.....	62
Flue Brush–Straight Wire, Double Spiral.....	58	Knot Wire Flared Cup Brush.....	39	Nylon/Polyester Blend Brush.....	153
Foam Paintbrush.....	159	Knot Wire Wheel Brush.....	22-23	Open Double Cloth Bias Sisal Buff.....	165
General Purpose Flap Brush.....	168	Knot Wire Wheel Brush– Extra Heavy Duty.....	24	Osborn Pro Economy Floor Broom.....	132–133
Green TY™ Encapsulated Tube Brush–Double Stem, Double Spiral.....	59	Knot Wire Wheel Brush– Heavy Duty.....	24	Ox Hair One Stroke Brush.....	159
Grinding Wheel–A.....	77	Knot Wire Wheel Brush–Wide Face, Heavy Duty.....	25	Ox Hair Sign Writer’s Brush.....	159
Grinding Wheel–AS.....	77	Knot Wire Wheel Brush with Shank.....	23	Parts Cleaning Brush.....	160
Grinding Wheel–EXT.....	77	Long Handle Utility Brush.....	140	Pilot Bonding End Brush.....	52
Grinding Wheel–Z.....	77	Loose Conventional Buff.....	166	Pipeline Grinding Wheel–A+.....	79
Grit Cup Brush with Shank.....	44	Master Sweep Floor Broom.....	133	Pipeline Grinding Wheel–EXT.....	79
Grit Wheel Brush with Shank.....	33	Metal Adapters for Brushes w/ 1-1/4" Arbor Hole.....	126	Plastic Handle Scratch Brush.....	147
HD Flap Disc–EXT.....	82	Metal Adapters for Brushes w/ 2" Arbor Hole.....	126	Plastic Small Cleaning Scratch Brush.....	147
HD Flap Disc–Z.....	83	Metal Adapters for Wide Face Brushes w/ 2" Arbor Holes.....	126	Plater’s Fiber Brush.....	144
Helituf Crimped Wire Internal Brush.....	56	Miniature Bristle Cup Brush.....	64	Plater’s Fine Wire Scratch Brush.....	144
High Speed Small Grinder Knot Wire Cup Brush.....	43	Miniature Bristle End Brush.....	65	Plater’s Shoe Handle Fiber Brush.....	144
High Speed Small Grinder Cable Knot Wheel Brush.....	27	Miniature Wheel Brush.....	63	Plater’s Wire Scratch Brush.....	144
High Speed Small Grinder Crimped Wire Cup Brush.....	42	Miniature Wire Cup Brush.....	63	Plater’s Wire Wheel Brush.....	32
High Speed Small Grinder Knot Wire Cup Brush–Heavy Duty.....	42	Miniature Wire End Brush.....	64	Polimaxx Polishing Flap Disc.....	84
High Speed Small Grinder Knot Wire Wheel Brush.....	25	Miniature Wire End Brush– Light Duty.....	64	Polyester Grey Bristle Brush with Bow Handle.....	153
High Speed Thread Adapters....	126	Nail Brush.....	139	Polyester Grey Bristle Brush with Kaiser Handle.....	154
Horsehair Tin Ferrule Acid Brush.....	159			Pure Black China Bristle Oval Sash Brush.....	156
				Pure Bristle Flat Artist’s or Fitch Marking Brush.....	157

Product	Page	Product	Page	Product	Page
Pure China Bristle Stencil Marking Brush	158	Straight Wire Valve Guide Brush	61	V-Trim Cleaning Scratch Brush.....	148
Pure Grey Bristle Brush	154	Stringer Bead Brush	26	V-Trim Long Handle Scratch Brush.....	145
Pure Grey China Bristle Oval Sash Brush	157	Strip Floor Broom.....	135	V-Trim Shoe Handle Brush.....	145
Pure Grey China Bristle Round Sash Brush	156	Tampico Wheel Brush	33	Window Brush	139
Pure White Bristle Round Marking Brush	158	TufBrush Stringer Bead Brush.....	26	Wire Broom.....	134
Pure White China Bristle.....	153	TY™ Black Max Encapsulated Cup Brush–Extra Heavy Duty.....	41	X-Lock Crimped Cup Brush	68
Pure White China Bristle Angular Sash Brush	155	TY™ Encapsulated Cup Brush– Standard Duty	41	X-Lock Cut-Off Wheel.....	87
Pure White China Bristle Flat Sash Tool Brush	154	TY™ Encapsulated Cup Brush with Shank–Standard Duty	41	X-Lock Diamond Blade	87
Radiator Brush.....	140	TY™ Encapsulated End Brush– Standard Duty	51	X-Lock Flap Disc	87
Red Sable Artist’s Brush.....	157	TY™ Encapsulated Flared End Brush–Heavy Duty	51	X-Lock Grinding Wheel	87
Ringlock Wire Wheel Brush	20	TY™ Encapsulated Wheel Brush– High Speed Knot Stringer, Heavy Duty	31	X-Lock Knotted Bevel Brush	68
Shoe Handle Wire Scratch Brush.....	146	TY™ Encapsulated Wheel Brush– Medium Face, Heavy Duty	30	X-Lock Knotted Cup Brush.....	68
Sibot Internal Finishing Brush.....	61	TY™ Encapsulated Wheel Brush– Medium Face, Standard Duty	29	X-Lock Knotted Radial Brush	68
Situft Crimped Wire Internal Brush	57	TY™ Encapsulated Wheel Brush– Narrow Face, Heavy Duty	28		
Situft Nylon Internal Brush.....	57	TY™ Encapsulated Wheel Brush– Narrow Face, Standard Duty.....	28		
Small Cleaning Scratch Brush...	146	TY™ Encapsulated Wheel Brush - Stringer Bead	30		
Small Cleaning Scratch Brush– Laced Back	147	TY™ Encapsulated Wheel Brush– Wide Face, Heavy Duty.....	29		
Small Diameter Nylon Wheel Brush	32	TY™ Encapsulated Wheel Brush– Wide Face, Standard Duty	29		
Small Diameter Tampico Wheel Brush	32	TY™ Encapsulated Wheel Brush– Wide Face, Standard Duty	29		
Small Diameter TY™ Encapsulated Wheel Brush–Standard Duty	30	Upright Corn Broom	134		
Stiff Whisk Broom	135	Utility Scrub Brush– Long Handle.....	142		
Straight Back Scratch Brush	147	Utility Scrub Brush– Short Handle.....	142		
Straight Handle Scratch Brush w/ Scraper	146	V-Groove Long Handle Scratch Brush.....	145		
Straight Wire Tube Brush–Double Stem, Double Spiral.....	58				

Numeric Index

Part No.	Page	Part No.	Page	Part No.	Page	Part No.	Page	Part No.	Page
0001100400.....20		0001114800....100		0001650100.....16		0002106100.....18		0002202500.....19	
0001100800.....20		0001114900....100		0001650200.....16		0002106300.....18		0002202600.....19	
0001101000.....20		0001115000....100		0001650400.....16		0002106700.....17		0002202900.....19	
0001101100.....20		0001115100....100		0001655200.....16		0002107100.....17		0002203000.....19	
0001101200.....20		0001115300....100		0001655400.....16		0002107600.....17		0002203800.....19	
0001101300.....20		0001115400....100		0001655500.....16		0002107700.....17		0002204500.....18	
0001101400.....20		0001115500....100		0001655900.....16		0002107800.....17		0002205200.....19	
0001101500.....20		0001118200.....32		0001656100.....16		0002108200.....21		0002206000.....19	
0001101600.....20		0001118300.....32		0001656200.....16		0002118200.....17		0002206100.....18	
0001101700.....20		0001118400.....32		0001656500.....16		0002118800.....17		0002206200.....18	
0001101800.....20		0001119000.....61		0001656900.....16		0002119500.....18		0002206400.....18	
0001101900.....20		0001119400.....61		0001657100.....16		0002120100.....17		0002206500.....18	
0001102800.....20		0001119800.....61		0001657200.....16		0002130000.....21		0002206600.....18	
0001102900.....20		0001120200.....61		0002001400.....33		0002130300.....21		0002207400.....18	
0001103100.....20		0001121000.....61		0002001600.....33		0002130400.....21		0002207600.....18	
0001103200.....20		0001133200....100		0002001800.....33		0002130900.....21		0002208000.....19	
0001103300.....20		0001133300....100		0002002000.....33		0002150300.....28		0002208100.....18	
0001103400.....20		0001133600....100		0002002200.....33		0002150400.....28		0002208200.....18	
0001104500.....20		0001133700....100		0002007900.....33		0002150600.....28		0002208500.....18	
0001104600.....20		0001161700.....30		0002011500.....33		0002150800.....28		0002208600.....18	
0001104800.....20		0001161900.....30		0002011600.....33		0002150900.....28		0002208700.....18	
0001105100.....20		0001162300.....30		0002064600.....100		0002151200.....28		0002209400.....18	
0001105200.....20		0001162500.....30		0002065400....100		0002152800.....28		0002209500.....18	
0001105600.....20		0001163200.....30		0002066000....100		0002154000.....28		0002210000.....19	
0001105800.....20		0001163300.....30		0002066500....100		0002155700.....28		0002210100.....19	
0001106000.....20		0001164700.....30		0002066600....100		0002158300.....17		0002210300.....19	
0001106100.....20		0001164800.....30		0002066700....100		0002158400.....17		0002210400.....19	
0001106200.....20		0001165000.....30		0002066800....100		0002158500.....17		0002210800.....19	
0001106300.....20		0001169800.....30		0002066900....100		0002158600.....17		0002210900.....18	
0001106500.....20		0001170200.....30		0002088400....100		0002158700.....17		0002211000.....18	
0001106600.....20		0001170500.....30		0002088600....100		0002158800.....18		0002211100.....18	
0001107000.....20		0001171800.....30		0002088700....100		0002159100.....17		0002211200.....18	
0001107300.....20		0001611900.....20		0002100300.....17		0002159200.....17		0002211400.....18	
0001107800.....20		0001613900.....20		0002100600.....18		0002159300.....17		0002212500.....18	
0001108500.....20		0001627800.....20		0002100700.....17		0002159500.....28		0002212600.....18	
0001108600.....20		0001629400.....20		0002100800.....18		0002159700.....18		0002213700.....18	
0001108800.....20		0001629500.....20		0002100900.....17		0002188900.....30		0002213800.....18	
0001109300.....20		0001643500.....37		0002101100.....18		0002196200.....17		0002213900.....18	
0001109400.....20		0001643600.....37		0002101300.....17		0002200300.....19		0002214000.....18	
0001109500.....20		0001643800.....37		0002101600.....17		0002200400.....19		0002214200.....18	
0001109700.....20		0001644000.....37		0002102000.....17		0002200500.....19		0002214600.....19	
0001110100.....20		0001646300.....16		0002102400.....18		0002200600.....19		0002214700.....19	
0001111100.....20		0001646600.....16		0002103100.....17		0002200700.....19		0002214800.....19	
0001111300.....32		0001646700.....16		0002103300.....17		0002200800.....19		0002214900.....19	
00011113400.....32		0001646800.....16		0002104100.....17		0002200900.....19		0002215000.....19	
00011113600.....32		0001647500.....16		0002104400.....17		0002201000.....19		0002215100.....19	
00011113900.....32		0001647800.....16		0002104600.....18		0002201200.....19		0002222500.....19	
00011114000.....32		0001648200.....16		0002104700.....17		0002201300.....19		0002224000.....99	
00011114100.....32		0001648300.....16		0002105000.....17		0002201400.....19		0002224400.....99	
00011114300.....32		0001648600.....16		0002105100.....17		0002201500.....19		0002224800.....99	
00011114400.....32		0001648800.....16		0002105200.....17		0002201600.....19		0002224900.....99	
00011114600....100		0001649600.....16		0002105600.....18		0002201700.....19		0002225000.....99	
00011114700....100		0001649700.....16		0002105900.....18		0002201800.....19		0002225100.....99	

Part No.	Page	Part No.	Page	Part No.	Page	Part No.	Page	Part No.	Page
0002225200.....99		0002323900.....26		0002616700.....24		0002649500.....26		0003010300.....49	
0002225300.....99		0002600400.....24		0002618500.....24		0002684200.....26		0003010400.....49	
0002225400.....99		0002600500.....24		0002618600.....23		0002686700.....25		0003010700.....49	
0002225500.....99		0002600600.....24		0002618700.....23		0002687500.....26		0003010900.....49	
0002225600.....99		0002601700.....22		0002618800.....23		0002690400.....26		0003011200.....49	
0002225700.....99		0002602800.....22		0002618900.....23		0002692700.....22		0003011300.....49	
0002225800.....99		0002602900.....22		0002619000.....23		0002692800.....22		0003011600.....48	
0002225900.....99		0002603000.....22		0002619100.....23		0002696400.....22		0003011800.....48	
0002227400.....18		0002603200.....26		0002620400.....24		0002722800.....27		0003012100.....48	
0002228500.....99		0002603800.....23		0002620600.....23		0002725000.....27		0003012200.....49	
0002228600.....99		0002603900.....22		0002620900.....23		0003000200.....49		0003012300.....49	
0002228700.....99		0002604000.....22		0002621000.....23		0003000400.....49		0003012800.....48	
0002228800.....99		0002604100.....22		0002621300.....25		0003000500.....49		0003013100.....48	
0002228900.....99		0002604200.....22		0002621400.....25		0003000800.....49		0003013300.....48	
0002229600.....99		0002604300.....22		0002621600.....24		0003001000.....49		0003013800.....48	
0002229700.....99		0002604600.....22		0002621800.....24		0003001100.....49		0003014100.....48	
0002229800.....99		0002604700.....22		0002622500.....23		0003001200.....49		0003014300.....48	
0002229900.....99		0002604800.....26		0002622600.....26		0003001400.....49		0003014500.....52	
0002230000.....99		0002605000.....22		0002623000.....23		0003001600.....49		0003014800.....52	
0002231200.....99		0002605800.....22		0002623100.....23		0003001700.....49		0003015100.....52	
0002231300.....99		0002605900.....22		0002623400.....24		0003001800.....49		0003015400.....52	
0002231400.....99		0002606000.....22		0002623500.....24		0003001900.....47		0003015700.....52	
0002231500.....99		0002606100.....22		0002623600.....24		0003002000.....47		0003019000.....52	
0002232500.....99		0002606200.....22		0002624000.....24		0003002100.....47		0003019300.....52	
0002232600.....99		0002606400.....22		0002625000.....24		0003002200.....47		0003019600.....52	
0002232700.....99		0002606500.....22		0002626100.....39		0003002500.....47		0003019900.....52	
0002232800.....99		0002606700.....22		0002630200.....22		0003002600.....50		0003022800.....48	
0002233300.....99		0002607000.....22		0002630600.....22		0003002800.....50		0003022900.....48	
0002233400.....99		0002607100.....22		0002634200.....23		0003002900.....50		0003023100.....48	
0002233500.....99		0002607200.....22		0002634400.....26		0003003200.....50		0003023200.....48	
0002233600.....99		0002607500.....22		0002634600.....23		0003003400.....50		0003023300.....48	
0002251000.....99		0002608100.....22		0002634700.....26		0003003500.....50		0003023400.....48	
0002251400.....99		0002608800.....26		0002635500.....25		0003003800.....50		0003024100.....53	
0002251500.....99		0002609300.....23		0002635800.....25		0003004000.....50		0003024700.....53	
0002251700.....99		0002609400.....25		0002635900.....25		0003004100.....50		0003025000.....48	
0002251800.....99		0002609800.....24		0002636000.....25		0003005100.....47		0003025100.....48	
0002251900.....99		0002609900.....24		0002636100.....31		0003005300.....47		0003025500.....48	
0002252000.....99		0002610100.....24		0002636300.....26		0003005500.....47		0003025800.....48	
0002252200.....99		0002610400.....24		0002636900.....26		0003005700.....47		0003026100.....64	
0002252300.....99		0002611200.....26		0002637500.....25		0003005900.....47		0003026200.....64	
0002252400.....99		0002611500.....24		0002637600.....25		0003006100.....47		0003026300.....64	
0002252700.....99		0002611600.....24		0002637700.....25		0003006300.....47		0003026500.....64	
0002252800.....99		0002611700.....24		0002638500.....25		0003006500.....47		0003027500.....53	
0002253300.....99		0002612100.....24		0002638600.....25		0003006700.....47		0003027600.....48	
0002253600.....99		0002612200.....24		0002639100.....25		0003007100.....47		0003027700.....48	
0002270100.....29		0002612900.....24		0002639200.....25		0003007400.....47		0003027800.....48	
0002270400.....29		0002613500.....24		0002639600.....26		0003007500.....49		0003027900.....48	
0002271800.....29		0002613700.....24		0002639800.....26		0003007900.....47		0003028000.....48	
0002277300.....29		0002615500.....24		0002639900.....26		0003008300.....47		0003028500.....110	
0002277400.....29		0002615700.....24		0002640000.....26		0003008500.....47		0003028700.....110	
0002278300.....29		0002615800.....24		0002645500.....27		0003009100.....47		0003029300.....110	
0002279400.....29		0002615900.....24		0002646100.....27		0003009200.....47		0003029500.....110	
0002323000.....26		0002616200.....24		0002646800.....26		0003009500.....49		0003029600.....110	

Numeric Index

Part No.	Page	Part No.	Page	Part No.	Page	Part No.	Page	Part No.	Page
0003029700.....	110	0003201200.....	37	0003307200.....	39	0003511700.....	57	0003617900.....	56
0003029800.....	110	0003201400.....	37	0003309100.....	39	0003511800.....	57	0003618700.....	56
0003029900.....	110	0003202600.....	42	0003312600.....	38	0003512700.....	57	0003618800.....	56
0003030000.....	110	0003202700.....	42	0003312700.....	38	0003513700.....	57	0003619500.....	56
0003030100.....	110	0003202900.....	42	0003312800.....	38	0003513800.....	57	0003620400.....	56
0003039500.....	49	0003203000.....	42	0003313300.....	38	0003517600.....	57	0003625000.....	112
0003039700.....	47	0003203200.....	42	0003313400.....	38	0003518100.....	57	0003625100.....	112
0003042600.....	49	0003203400.....	42	0003313500.....	38	0003518900.....	57	0003625200.....	112
0003042800.....	49	0003204000.....	36	0003313700.....	38	0003519700.....	57	0003625300.....	112
0003042900.....	49	0003204600.....	37	0003313800.....	38	0003520500.....	57	0003625400.....	112
0003043200.....	49	0003204700.....	36	0003313900.....	38	0003521300.....	57	0003625500.....	112
0003043400.....	49	0003204800.....	36	0003315000.....	38	0003522100.....	57	0003625600.....	112
0003043500.....	49	0003204900.....	36	0003319800.....	40	0003522900.....	57	0003625700.....	112
0003043800.....	49	0003205600.....	36	0003335500.....	43	0003524500.....	57	0003625800.....	112
0003044000.....	49	0003207200.....	37	0003335600.....	43	0003528100.....	57	0003625900.....	112
0003044100.....	49	0003207400.....	37	0003335700.....	43	0003529000.....	57	0003626000.....	112
0003050000.....	49	0003207800.....	37	0003335800.....	43	0003529300.....	57	0003626100.....	112
0003050200.....	49	0003208000.....	37	0003335900.....	43	0003531100.....	57	0003630200.....	113
0003050300.....	49	0003208600.....	42	0003336000.....	43	0003535800.....	57	0003630300.....	113
0003050400.....	49	0003212500.....	108	0003336400.....	43	0003550000.....	112	0003630400.....	113
0003050500.....	49	0003212700.....	108	0003336700.....	43	0003550100.....	112	0003630800.....	113
0003055800.....	51	0003213100.....	108	0003345600.....	43	0003550300.....	112	0003631000.....	113
0003055900.....	51	0003213200.....	108	0003345800.....	43	0003550500.....	112	0003631100.....	113
0003060000.....	51	0003213300.....	108	0003345900.....	43	0003601200.....	56	0003631200.....	113
0003060200.....	51	0003213400.....	36	0003346000.....	43	0003602200.....	56	0003631400.....	113
0003060400.....	51	0003213500.....	36	0003346600.....	43	0003602300.....	56	0003631500.....	113
0003060500.....	51	0003213600.....	36	0003346700.....	43	0003602700.....	56	0003631600.....	113
0003060700.....	51	0003213700.....	108	0003346800.....	43	0003603200.....	56	0003631700.....	113
0003060900.....	51	0003213800.....	108	0003397200.....	39	0003603300.....	56	0003635800.....	113
0003061200.....	51	0003214100.....	36	0003502100.....	57	0003603700.....	56	0003636200.....	113
0003061400.....	51	0003214400.....	36	0003502300.....	57	0003604200.....	56	0003636400.....	113
0003061500.....	51	0003214600.....	109	0003502700.....	57	0003604300.....	56	0003636600.....	113
0003061900.....	51	0003214800.....	108	0003503100.....	57	0003604700.....	56	0003637000.....	113
0003062200.....	51	0003214900.....	108	0003503200.....	57	0003605200.....	56	0003637100.....	113
0003065000.....	51	0003261000.....	41	0003504100.....	57	0003605300.....	56	0003639400.....	113
0003065100.....	51	0003262900.....	41	0003504200.....	57	0003605700.....	56	0003639600.....	113
0003065300.....	51	0003263100.....	41	0003504300.....	57	0003606200.....	56	0003639900.....	113
0003065500.....	51	0003264800.....	41	0003505100.....	57	0003606300.....	56	0003640000.....	113
0003065900.....	51	0003266000.....	41	0003505200.....	57	0003606700.....	56	0003665000.....	113
0003066100.....	51	0003300000.....	42	0003506100.....	57	0003607200.....	56	0003665100.....	113
0003066300.....	51	0003300100.....	42	0003506200.....	57	0003607300.....	56	0003665200.....	113
0003066600.....	51	0003300500.....	38	0003506300.....	57	0003608200.....	56	0003665400.....	113
0003066700.....	51	0003300600.....	38	0003507700.....	57	0003609300.....	56	0003665500.....	113
0003066900.....	51	0003301100.....	38	0003507800.....	57	0003613900.....	56	0003665600.....	113
0003067100.....	51	0003301500.....	38	0003508100.....	57	0003614700.....	56	0003665800.....	113
0003087000.....	110	0003302100.....	38	0003508200.....	57	0003614800.....	56	0003665900.....	113
0003087200.....	110	0003302200.....	38	0003508600.....	57	0003615100.....	56	0003666000.....	113
0003087500.....	110	0003302400.....	38	0003508700.....	57	0003615500.....	56	0003666100.....	113
0003087600.....	110	0003302600.....	38	0003508800.....	57	0003615600.....	56	0003666200.....	113
0003087700.....	110	0003303000.....	38	0003509600.....	57	0003616300.....	56	0003666400.....	113
0003200200.....	41	0003303400.....	38	0003509700.....	57	0003616400.....	56	0003666500.....	113
0003200400.....	37	0003304500.....	38	0003509800.....	57	0003616700.....	56	0003666600.....	113
0003200600.....	37	0003304900.....	38	0003510700.....	57	0003617200.....	56	0003666800.....	113

Part No.	Page	Part No.	Page	Part No.	Page	Part No.	Page	Part No.	Page
0003666900....113		0004100200....124		0004723400....105		0005105300.....58		0005114700.....61	
0003670000.....60		0004101200....124		0004723500....105		0005105400.....58		0005114800.....61	
0003670400.....60		0004702100....103		0004724000....105		0005105600.....58		0005114900.....62	
0003670800.....60		0004702200....103		0004724100....105		0005106000.....58		0005115000.....62	
0003670900.....60		0004702300....103		0004725100....105		0005106100.....58		0005115100.....62	
0003671600.....60		0004702400....103		0004725200....105		0005106200.....58		0005115200.....62	
0003671700.....60		0004702500....103		0004725400....105		0005106300.....58		0005115300.....62	
0003672000.....60		0004702600....103		0004725600....105		0005106400.....58		0005115400.....62	
0003672400.....60		0004702700....103		0004725700....105		0005106500.....58		0005115500.....62	
0003672500.....60		0004702800....103		0004725900....105		0005106600.....58		0005205300....133	
0003672800.....60		0004702900....103		0004726100....105		0005106700.....58		0005205400....133	
0003673200.....60		0004703000....103		0004726200....105		0005106800.....58		0005206100....134	
0003673300.....60		0004703200....103		0004726400....105		0005106900.....58		0005211000....135	
0003673600.....60		0004703300....103		0004750100....103		0005107000.....58		0005211100....135	
0003674800.....60		0004703500....103		0004750300....103		0005107100.....58		0005211400....135	
0003674900.....60		0004703600....103		0004750600....103		0005107200.....58		0005211500....135	
0003675700.....60		0004703700....103		0004750700....103		0005107400.....58		0005211800....135	
0003676000.....60		0004703900....103		0004750800....103		0005107500.....61		0005211900....135	
0003676100.....60		0004704100....103		0004752000....104		0005107600.....61		0005212300....135	
0004016300.....98		0004704200....103		0004752100....104		0005108000.....60		0005230100....132	
0004016400.....98		0004705100....103		0004752400....104		0005108100.....60		0005230700....132	
0004019200.....98		0004705300....103		0004785200....105		0005108200.....60		0005231100....132	
0004019500.....98		0004705700....103		0004785500....105		0005108300.....60		0005231200....132	
0004053100.....97		0004705900....103		0004785900....105		0005108500.....59		0005231600....132	
0004053700.....98		0004706600....103		0004786000....105		0005108600.....59		0005231700....132	
0004054000.....98		0004706700....103		0004786100....105		0005108700.....59		0005232600....132	
0004054100.....98		0004708100....104		0004786600....105		0005108800.....59		0005232700....132	
0004054300.....98		0004708300....104		0005100100.....60		0005109000.....59		0005233600....132	
0004058600.....97		0004708400....104		0005100200.....60		0005109100.....59		0005233700....132	
0004058700.....97		0004708500....104		0005100300.....60		0005109300.....59		0005400100....137	
0004058800.....97		0004708700....104		0005100400.....60		0005109600.....59		0005400300....137	
0004059000.....97		0004708900....104		0005100500.....60		0005109900.....59		0005400400....137	
0004059400.....98		0004709500....104		0005100600.....60		0005110000.....62		0005400500....137	
0004059500.....98		0004710100....104		0005100700.....60		0005110100.....62		0005400600....137	
0004059600.....98		0004711300....104		0005100800.....60		0005110200.....62		0005400700....137	
0004059700.....98		0004712300....104		0005101900.....59		0005110300.....62		0005400800....137	
0004062100.....97		0004712500....104		0005102000.....59		0005110400.....62		0005401300....146	
0004062200.....97		0004712600....104		0005102100.....59		0005110500.....62		0005401400....146	
0004062300.....97		0004714000....106		0005102200.....59		0005110600.....62		0005401500....145	
0004062400.....97		0004714100....106		0005102300.....59		0005110800.....62		0005401700....145	
0004062500.....97		0004714200....106		0005102400.....59		0005110900.....62		0005401800....146	
0004062600.....97		0004714300....106		0005102500.....59		0005111000.....59		0005401900....146	
0004064900.....97		0004714400....106		0005102700.....59		0005111100.....59		0005402000....146	
0004065200.....98		0004714500....106		0005102800.....59		0005111200.....59		0005402100....146	
0004065400.....98		0004714800....106		0005103000.....59		0005111300.....59		0005402200....146	
0004082100.....98		0004716100....105		0005103100.....59		0005111400.....59		0005402300....146	
0004082300.....98		0004716300....105		0005103300.....59		0005112200.....59		0005402800....147	
0004082500.....98		0004717500....105		0005103700.....59		0005114100.....61		0005403000....146	
0004088600.....97		0004718500....105		0005103800.....59		0005114200.....61		0005403100....146	
0004088800.....97		0004720000....106		0005103900.....59		0005114300.....61		0005403200....145	
0004089600.....98		0004720100....106		0005105000.....58		0005114400.....61		0005403300....146	
0004100000....124		0004720200....106		0005105100.....58		0005114500.....61		0005403500....144	
0004100100....124		0004720300....106		0005105200.....58					

Numeric Index

Part No.	Page	Part No.	Page	Part No.	Page	Part No.	Page	Part No.	Page
0005403600....	144	0005608600....	114	0007009400....	156	0007129000....	155	0007406700....	157
0005403700....	144	0005620000....	139	0007009500....	156	0007202500....	154	0007406800....	157
0005403800....	144	0005631200....	112	0007010000....	157	0007202600....	154	0007406900....	157
0005403900....	144	0005631500....	112	0007010100....	157	0007202700....	154	0007407000....	157
0005404000....	144	0005631600....	112	0007010200....	157	0007203000....	155	0007407100....	157
0005404600....	144	0005640000....	114	0007010300....	157	0007203100....	155	0007500700....	127
0005404700....	144	0005640300....	114	0007010500....	157	0007203200....	155	0007500800....	127
0005404800....	146	0005640600....	114	0007010700....	158	0007302000....	159	0007500900....	127
0005405000....	147	0005640700....	114	0007010800....	158	0007302100....	159	0007501000....	127
0005405300.....	32	0005640900....	114	0007010900....	158	0007302200....	159	0007502100....	126
0005405500.....	32	0005641000....	114	0007011500....	160	0007302300....	159	0007502200....	126
0005406100....	139	0005641200....	114	0007015000....	153	0007302400....	159	0007502300....	126
0005406200....	139	0005641400....	114	0007015100....	153	0007302700....	160	0007502400....	126
0005406700....	142	0005641500....	114	0007015200....	153	0007302800....	160	0007502500....	126
0005407100....	142	0005641700....	114	0007015300....	153	0007303500....	155	0007502600....	126
0005407200....	142	0005641800....	114	0007015400....	153	0007400100....	158	0007502700....	126
0005407300....	142	0005641900....	114	0007015500....	153	0007400200....	158	0007502800....	126
0005407400....	142	0005642500....	115	0007015600....	153	0007400300....	158	0007503800....	126
0005407500....	142	0005642600....	114	0007037400....	159	0007400400....	158	0007503900....	126
0005407600....	142	0005642700....	115	0007037500....	159	0007400500....	158	0007504000....	126
0005407700.....	44	0005642800....	114	0007037600....	159	0007400600....	158	0007504100....	126
0005407900....	139	0005642900....	115	0007037700....	159	0007401000....	158	0007504800....	126
0005410000....	148	0005643000....	114	0007090000....	140	0007401100....	158	0007504900....	126
0005410100....	148	0005643200....	115	0007090100....	140	0007401200....	158	0007505000....	126
0005410200....	148	0005643300....	114	0007090200....	140	0007401300....	158	0007505200....	126
0005410300....	145	0005643500....	115	0007105700....	153	0007401400....	158	0007505910....	127
0005410400....	145	0005643700....	114	0007105800....	153	0007401500....	158	0007506010....	127
0005410500....	145	0005643800....	115	0007105900....	153	0007402000....	157	0007506110....	127
0005410600....	145	0005643900....	114	0007106000....	153	0007402100....	157	0007506210....	127
0005438700....	145	0005644100....	115	0007106100....	153	0007402200....	157	0007507700....	127
0005438800....	145	0005644200....	114	0007106200....	153	0007402300....	157	0007508000....	127
0005600100....	135	0005644400....	115	0007110000....	153	0007402400....	157	0007511600....	148
0005600200....	135	0005644600....	114	0007110100....	153	0007402500....	157	0007511700....	127
0005600700....	140	0005644700....	115	0007110200....	153	0007402700....	157	0007511800....	127
0005601000....	112	0005644800....	114	0007110400....	153	0007402900....	157	0007514600....	134
0005601100....	112	0005645000....	115	0007110500....	153	0007403000....	158	0007514700....	134
0005601200....	112	0005970100....	147	0007110600....	154	0007403100....	158	0007514800....	134
0005601300....	112	0005970200....	147	0007110700....	154	0007403200....	158	0007515000....	135
0005601500....	112	0005970300....	147	0007110800....	154	0007403300....	158	0007518300....	126
0005601600....	112	0007006700....	153	0007110900....	154	0007403400....	158	0007518500....	126
0005607300....	114	0007006800....	153	0007111000....	154	0007403500....	158	0007518700....	126
0005607400....	114	0007006900....	153	0007111200....	156	0007404000....	159	0007566500.....	64
0005607500....	114	0007007000....	153	0007111300....	156	0007404100....	159	0007567000.....	64
0005607600....	114	0007007100....	153	0007111400....	156	0007404200....	159	0007567500.....	64
0005607700....	114	0007007200....	153	0007111500....	156	0007404300....	159	0007567700.....	64
0005607800....	114	0007007300....	153	0007111600....	157	0007404400....	159	0007568000.....	64
0005607900....	114	0007008500....	154	0007111700....	157	0007404500....	159	0007568500.....	64
0005608000....	114	0007008700....	154	0007111800....	157	0007405900....	159	0007568600....	116
0005608100....	114	0007008900....	155	0007111900....	157	0007406000....	159	0007568700....	116
0005608200....	114	0007009000....	155	0007112000....	157	0007406100....	159	0007569200....	116
0005608300....	114	0007009100....	156	0007112100....	157	0007406200....	159	0007569300....	116
0005608400....	114	0007009200....	156	0007113500....	160	0007406500....	157	0007569500.....	64
0005608500....	114	0007009300....	156	0007113600....	160	0007406600....	157	0007569800....	116

Part No.	Page	Part No.	Page	Part No.	Page	Part No.	Page	Part No.	Page
0007570000.....	64	0007722500....	119	0007730800....	119	0007738000....	119	0008300200....	147
0007570100.....	63	0007722600....	119	0007730900....	119	0007738100....	119	0008300300....	146
0007570500.....	63	0007722700....	119	0007731100....	120	0008100300....	137	0008300500....	146
0007570600....	116	0007722800....	119	0007731200....	120	0008100400....	137	0008300800....	146
0007570700....	116	0007722900....	119	0007731300....	120	0008120100....	132	0008310000....	145
0007571000.....	63	0007723000....	119	0007731400....	120	0008120200....	132	0008310100....	145
0007571500.....	63	0007723200....	119	0007731500....	120	0008120600....	132	0008311100....	147
0007571700.....	65	0007723300....	119	0007731600....	120	0008120700....	132	0008311200....	147
0007571900.....	65	0007723500....	119	0007731700....	120	0008120800....	132	0008311300....	147
0007572400.....	65	0007723700....	119	0007731800....	120	0008120900....	132	0008400400....	145
0007574900.....	63	0007723800....	119	0007732000....	120	0008121100....	132	0008401000....	146
0007575000.....	63	0007723900....	119	0007732100....	120	0008121200....	132	0008600100....	155
0007575100....	116	0007724000....	119	0007732200....	120	0008121300....	132	0008600200....	155
0007575200....	116	0007724100....	119	0007732400....	120	0008121400....	132	0008600300....	155
0007575300.....	63	0007724500....	119	0007732500....	119	0008121600....	132	0008600400....	155
0007575400.....	63	0007724600....	119	0007732600....	119	0008121700....	132	0008600500....	155
0007575500.....	63	0007724700....	119	0007732700....	119	0008122100....	132	0008600600....	155
0007575600.....	63	0007724800....	119	0007732800....	120	0008122200....	132	0008600700....	155
0007575700.....	63	0007724900....	119	0007733100....	120	0008122600....	132	0008601400....	155
0007575800.....	63	0007725000....	119	0007733200....	120	0008122700....	132	0008601500....	155
0007575900.....	63	0007725100....	119	0007733300....	120	0008123100....	132	0008601600....	155
0007576000.....	63	0007725200....	119	0007733400....	120	0008123300....	132	0008601700....	155
0007576400.....	63	0007725300....	119	0007733500....	120	0008123400....	132	0008601800....	155
0007576500....	116	0007725500....	119	0007733700....	120	0008123600....	133	0008601900....	155
0007576600....	116	0007725600....	119	0007734100....	120	0008123700....	133	0008602000....	155
0007576800.....	63	0007725700....	119	0007734200....	119	0008123900....	133	0008602100....	156
0007577000....	116	0007725800....	119	0007734300....	119	0008124100....	133	0008602200....	156
0007577200.....	63	0007725900....	119	0007734400....	119	0008124200....	133	0008602300....	156
0007577400....	116	0007726000....	119	0007734500....	120	0008124600....	133	0008602400....	156
0007578000.....	64	0007726100....	119	0007734900....	120	0008124700....	133	0008602600....	156
0007578100.....	64	0007726200....	119	0007735000....	120	0008124800....	133	0008602700....	156
0007578200.....	64	0007726400....	119	0007735200....	120	0008125100....	133	0008612800....	156
0007597500....	160	0007726600....	119	0007735300....	120	0008125200....	133	0008612900....	156
0007720000....	119	0007726700....	119	0007735400....	120	0008125300....	133	0008613000....	156
0007720100....	119	0007726800....	119	0007735800....	120	0008126000....	133	0008613100....	156
0007720200....	119	0007726900....	119	0007735900....	119	0008126100....	133	0008613200....	156
0007720300....	119	0007727000....	119	0007736000....	119	0008126200....	133	0008613300....	154
0007720400....	119	0007727100....	119	0007736100....	119	0008126400....	134	0008613400....	154
0007720500....	119	0007727400....	119	0007736200....	119	0008126500....	134	0008613500....	154
0007720600....	119	0007727800....	119	0007736300....	119	0008127400....	134	0008613600....	154
0007720700....	119	0007727900....	119	0007736400....	119	0008127500....	134	0008613700....	154
0007720900....	119	0007728000....	119	0007736500....	119	0008127900....	134	0008614300....	156
0007721000....	119	0007728100....	119	0007736700....	119	0008128000....	134	0008614400....	154
0007721100....	119	0007728300....	119	0007736800....	119	0008128400....	132	0009900100.....	16
0007721200....	119	0007729700....	119	0007736900....	119	0008128500....	132	0009900200.....	16
0007721300....	119	0007729800....	119	0007737000....	119	0008128900....	132	0009900300.....	16
0007721400....	119	0007729900....	119	0007737100....	119	0008129000....	132	0009900600.....	16
0007721500....	119	0007730000....	119	0007737200....	119	0008129400....	133	0009900700.....	16
0007721600....	119	0007730100....	119	0007737300....	119	0008129500....	133	0009900800.....	17
0007721700....	119	0007730200....	119	0007737400....	119	0008129600....	133	0009900900.....	17
0007722000....	119	0007730300....	119	0007737500....	119	0008129900....	133	0009901000.....	17
0007722100....	119	0007730500....	119	0007737700....	119	0008130000....	133	0009901100.....	18
0007722300....	119	0007730700....	119	0007737900....	119	0008300100....	145	0009901200.....	18

Numeric Index

Part No.	Page	Part No.	Page	Part No.	Page	Part No.	Page	Part No.	Page
0009901300.....	18	0009909800.....	49	1183250572.....	74	5212384572.....	83	1183251072R ...	74
0009901400.....	18	0009909900.....	49	1183251572.....	74	5212386572.....	83	3113551072R ...	79
0009901500.....	18	0009910000.....	49	1911240572.....	87	5212387572.....	83	3116520072R ...	77
0009901600.....	18	0009910100.....	49	1911246572.....	87	5212389572.....	83	3116540072R ...	77
0009901700.....	18	0009910200.....	49	1911250572.....	87	5212444572.....	82	3117560072R ...	77
0009901900.....	19	0009910300.....	49	1911251572.....	87	5212446572.....	82	3126520072R ...	77
0009902100.....	19	0009910400.....	47	1921240572.....	87	5212447572.....	82	3156560072R ...	77
0009902200.....	19	0009910500.....	47	1921246572.....	87	5212449572.....	82	3186540072R ...	77
0009902300.....	19	0009910600.....	47	3113551572.....	79	5212454572.....	83	5211384072R ...	83
0009902400.....	36	0009910700.....	47	3116520572.....	77	5212456572.....	83	5211386072R ...	83
0009902500.....	36	0009910800.....	47	3116540572.....	77	5212457572.....	83	5211387072R ...	83
0009902600.....	36	0009911700.....	33	3116560572.....	77	5212459572.....	83	5211389072R ...	83
0009902700.....	36	0009911800.....	33	3117560572.....	77	5212474572.....	82	5211444072R ...	82
0009902800.....	36	0009911900.....	33	3123551572.....	79	5212476572.....	82	5211446072R ...	82
0009902900.....	36	0009912000.....	33	3126520572.....	77	5212477572.....	82	5211447072R ...	82
0009903000.....	36	0009912100.....	44	3126540572.....	77	5212479572.....	82	5211449072R ...	82
0009903300.....	36	0009912200.....	44	3126560572.....	77	5215384572.....	83	5211454072R ...	83
0009903400.....	36	0009912300.....	44	3127561572.....	77	5215386572.....	83	5211456072R ...	83
0009903500.....	36	0009912400.....	44	3156041572.....	77	5215387572.....	83	5211457072R ...	83
0009903600.....	38	0009913000.....	22	3156520572.....	77	5215389572.....	83	5211459072R ...	83
0009903700.....	38	0009913100.....	43	3156560572.....	77	5215444572.....	82	5211474072R ...	82
0009903800.....	38	0009913200.....	43	3186520572.....	77	5215446572.....	82	5211476072R ...	82
0009903900.....	38	0804608131.....	68	3186540572.....	77	5215447572.....	82	5215384072R ...	83
0009904000.....	38	0804608151.....	68	3186560572.....	77	5215449572.....	82	5215386072R ...	83
0009904100.....	38	0804608331.....	68	3187560572.....	77	5218184572.....	83	5215387072R ...	83
0009904300.....	38	0804608351.....	68	3916040572.....	87	5218186572.....	83	5215389072R ...	83
0009904400.....	38	0804613162.....	68	3916540572.....	87	5218187572.....	83	5215444072R ...	82
0009904600.....	38	0804613362.....	68	3926040572.....	87	5218384572.....	83	5215446072R ...	82
0009904700.....	38	0804622131.....	68	3926540572.....	87	5218386572.....	83	5215447072R ...	82
0009904900.....	43	0804622151.....	68	4914185572.....	87	5218387572.....	83	5215449072R ...	82
0009905000.....	43	0804631131.....	68	4915514572.....	87	5218434572.....	82	5218344072R ...	83
0009905100.....	43	0804631151.....	68	4924185572.....	87	5218436572.....	82	5218346072R ...	83
0009905300.....	43	0804631331.....	68	4925514572.....	87	5218437572.....	82	5218444072R ...	82
0009906000.....	27	0804631351.....	68	5211184572.....	83	5218444572.....	82	5218446072R ...	82
0009906200.....	27	1111240572.....	74	5211186572.....	83	5218446572.....	82	5218447072R ...	82
0009906600.....	22	1111246572.....	74	5211187572.....	83	5218447572.....	82	5218449072R ...	82
0009906900.....	25	1111250572.....	74	5211384572.....	83	5541204572.....	84		
0009907100.....	22	1111251572.....	74	5211386572.....	83	5541206572.....	84		
0009907300.....	22	1111500572.....	74	5211387572.....	83	5541207572.....	84		
0009907500.....	22	1113251572.....	74	5211434572.....	82	5541220572.....	84		
0009907600.....	23	1113270572.....	79	5211436572.....	82	5831184572.....	87		
0009907700.....	23	1120240572.....	74	5211437572.....	82	5831186572.....	87		
0009907800.....	23	1121240572.....	74	5211444572.....	82	5831187572.....	87		
0009907900.....	23	1121500572.....	74	5211446572.....	82	5831189572.....	87		
00099082B0R.....	26	1121512572.....	74	5211447572.....	82	5832184572.....	87		
0009908300.....	26	1122240572.....	74	5211454572.....	83	5832186572.....	87		
0009908600.....	26	1123240572.....	74	5211456572.....	83	5832187572.....	87		
00099088B0R.....	26	1123270572.....	79	5211457572.....	83	5832189572.....	87		
0009909200.....	27	1151240572.....	74	5211459572.....	83	1113250072R ...	74		
0009909300.....	27	1151246572.....	74	5211474572.....	82	1113251072R ...	74		
0009909400.....	21	1151250572.....	74	5211476572.....	82	1113270072R ...	79		
0009909500.....	21	1153270572.....	79	5211477572.....	82	1123270072R ...	79		
0009909600.....	21	1153511572.....	74	5211479572.....	82	1183250072R ...	74		



osborn.com